

K&L GATES



**ATKINS**  
Member of the SNC-Lavalin Group

# Offshore Wind Handbook

---

October 2018



— Courtesy of Atkins

# Table of Contents

Introduction	5
Offshore Wind Overview	7
Introduction	7
Market Drivers	8
Global Market Overview	8
U.S. Market Overview	10
Laws and Regulations Shaping Offshore Wind Development	13
U.S. Federal Offshore Policy and Regulatory Issues	13
U.S. State Offshore Policy and Regulatory Issues	19
Massachusetts	19
Maine	19
Maryland	20
New Jersey	20
Rhode Island	20
Connecticut	21
New York	21
Virginia	22
California	22
Hawaii	23
The Jones Act Maritime Law	24
U.S. Offshore Wind Legal Framework	29
Equipment Supply/EPC and Long-Term Service Agreements	29
Interconnection Issues—FERC and ISO	32
Power Purchase Agreements	36
Renewable Energy Tax Credits	42
Project Phasing	45
Project Planning	45



Consent and Permitting	49
Project Permitting	49
Planning and Analysis	49
Leasing	49
Site Assessment	50
Construction and Operations Plan	51
Other Pre-Construction Permits and Coordination	52
Post-Construction Mitigation and Monitoring	52
The Offshore Wind Infrastructure	55
Offshore Wind Turbines (WTG)	55
WTG Foundations and Substructures	56
Offshore Electrical Systems and Subsea Cables	58
Development—Barriers and Risks	63
Construction and Offshore Installation	67
The Marine Environment	67
Manufacturing	67
Offshore Installation	68
Commissioning	73
Asset Management and Decommissioning	75
Operations and Maintenance	75
Life Extension	76
Decommissioning	77
Appendix A: Contributors	79
Appendix B: Company Background	80
K&L Gates	80
Atkins	81



*Dudgeon Offshore Wind Farm—Courtesy of Smulders*

# Introduction

The much-anticipated dawn of the offshore wind energy industry in the U.S. is now upon us. Through the hard-earned progress of industry and governmental leaders in the U.S. and abroad, we now see a project development landscape of favorable policy and regulatory programs, advantageous pricing for proven reliable technology and construction services, and a pool of specialized expertise necessary for successful project development. All of these factors lead to the aggressive pricing we are now seeing in the power markets, with a likelihood of further cost compression to come. The time is now and the opportunity is before us.

First harnessed more than twenty years ago, the offshore wind industry is set for dramatic global growth. As the industry matures in Europe and developers in Asia and North America move to follow Europe's example, legal and regulatory frameworks are evolving quickly to accelerate project deployment and integrate these resources into the legacy power market. According to the Global Wind Energy Council's "Global Wind 2017 Report," over all there is now 18,814 MW of installed offshore wind power capacity globally, representing a 30% increase in cumulative capacity in 2017. Advances in technology and efficiencies in installation have contributed to huge reductions in the cost of offshore wind power and this is expected to continue. In addition to the obvious green credentials, offshore wind power is now economically competitive. No surprise then that interest in the sector is booming.

This Handbook is the result of collaboration between SNC-Lavalin's Atkins business, an international leader in the offshore wind design and construction industry and K&L Gates, a leading international law firm. The intent of this Handbook is to review the current progress in the U.S. offshore wind market and to outline some of the challenges faced by this dynamic and expanding market.



**David P. Hattery**

Practice Group Coordinator—Power Group, Seattle, USA



**Úna Brosnan**

Business & Strategy Development Manager, Glasgow, UK



*Block Island Offshore Wind Farm—Courtesy of Deepwater Wind*

# Offshore Wind Overview

AUTHOR: **Úna Brosnan**, Atkins

## Introduction

The offshore wind industry was launched in 1991 with the construction of the first offshore windfarm (Vindeby) off the coast of Denmark with eleven 450 kW turbines. The industry has continued to build on this technology which has naturally led to Europe now being the leader in offshore wind power.

Offshore wind energy is the use of wind farms constructed in the ocean (traditionally on a shallow continental shelf) to harvest wind energy to generate electricity. The development of the shallower (typically up to 60m water depths) coastal areas utilizing transitional fixed bottom substructures has been dominant to date and has experienced significant cost reduction in the last three years. Deep water areas are now also being explored that would utilize floating wind turbines. This floating technology is becoming more feasible as technical readiness levels improve and larger scale developments are deployed. Expect to see significant cost reductions with this technology in the coming years as developments continue to progress from demonstration developments to full scale commercialization.

There are many benefits of locating the wind turbines offshore namely:

- > Abundance of space offshore.
- > Higher and less turbulent wind resources offshore compared to on land therefore higher generation per amount of capacity installed.
- > Lower levels of offshore wind turbulence resulting in higher capacity factors (typically 40% higher than onshore wind).
- > Opposition to offshore wind farms tends to be lower due to its offshore location and distance from populated areas and reduced visual impact.
- > Use of larger turbines in offshore location—the size of the turbines is significantly higher with turbines available from 3.6MW - 9.5MW to date with a future turbine of 12GW recently announced by General Electric.
- > In the early days of offshore wind development, the cost was high (typically US\$215/MWh) however in recent years offshore wind costs have tumbled (~US\$76/MWh). The industry's success in reducing the overall cost can be attributed to the following:
  - > Strong, stable political drivers and support mechanisms
  - > Larger turbines
  - > Collaboration
  - > Innovation
  - > Standardizing
  - > Repeatability
  - > Industrialization
  - > Market competition
  - > A better understanding of risk
  - > Cheaper financing

## Market Drivers

The demand for global electricity is growing and projected to continue this trajectory with the transition to low carbon forms of energy. The energy trilemma is a term which is frequently used at political levels to describe the balance requirement between energy security, social impact and environmental sensitivity. The fundamental drivers for offshore wind globally are orientated around energy security, de-carbonization and industrial/job-creation and are likely to persist in importance in the future. The significant cost reductions experienced in recent years are now driving offshore wind development globally post 2020 toward 2030 with international governments and customers placing a larger emphasis on nations for greener, more secure and cheaper forms of energy. Offshore wind has now become a strong contender in their overall energy mix.

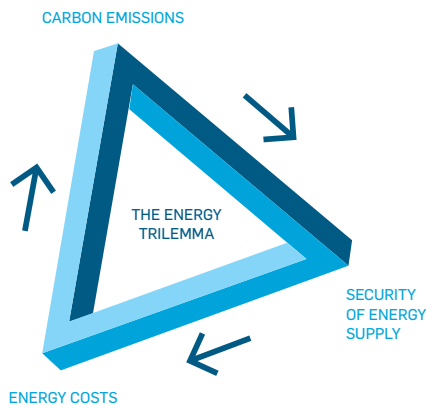

Offshore Wind resource development would help the  
**U.S. ACHIEVE 20% OF ITS ELECTRIC POWER**  
- NREL Report

## Global Market Overview

The UK is currently leading the way in offshore wind and has the world's largest offshore wind market with over 7GW (2018) of installed capacity which accounts for just over 36% of the global installed capacity. 2017 in particular, was a spectacular year for the offshore wind sector with some key milestone events, such as over 4.3 GW of new offshore wind power installed in one year across nine markets globally which represented an increase of 95% on the 2016 market.

In 2017 the world's first zero subsidy bids for offshore wind were proposed in Germany and a full 'zero subsidy' tender awarded in The Netherlands. Overall, there is over 18.8GW of installed offshore wind capacity in 17 markets around the world with proposals for larger turbines, in the order of 12MW to 15MW, being proposed to deliver the above mentioned zero bid/zero subsidy projects.

In the initial days, offshore wind was expensive compared to conventional forms of generation and required heavy subsidy support to drive the industry maturity. In 2013, the UK government challenged the industry to drastically lower costs and reduce the burden on the consumer and set a target of £100/MWh for projects going through Financial Close (~US \$135/MWh) by 2020. At the time this was deemed to be a very challenging target. Industry embraced the challenge and costs tumbled through technology maturity in subsequent years. In 2017 the £100/MWh goal was achieved across UK projects going through Financial Close therefore the challenge was beaten by three years. The UK Contract of Difference (CFD) auction held in 2017 saw unprecedented prices as low as £57.50/MWh (~US \$78/MWh) with further auctions in Europe supporting similar prices.

The key drivers for industry cost reduction were attributed to stable energy policy, technology innovation, the introduction of larger turbines, serial fabrication, buying power driven by volume and



cheaper finance. The demonstration of industry maturity in the market coupled with lower cost has now triggered a global interest in offshore wind with emerging global markets such as the U.S., China and Taiwan. We are also seeing new countries such as Turkey, Poland, Brazil, India and Australia now expressing interests in growing offshore wind into their energy portfolio. Going forward to 2020, UK is expected to lead the acceleration of the offshore wind portfolio with another round of CFDs due to be issued in 2019 which is expected to release subsidy to develop what is expected to be a pipeline in excess of 7.6GW of further offshore wind projects.

Figure two on the right, provides a high-level overview on the global offshore wind development portfolio by Country in MW.

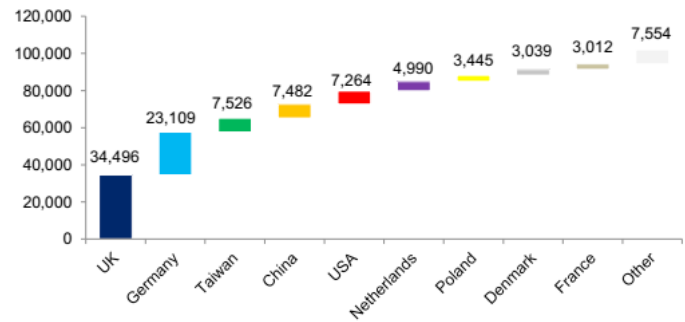

Figure 2 Global Offshore Wind Development Portfolio by country in MW (Source: Renewable UK)

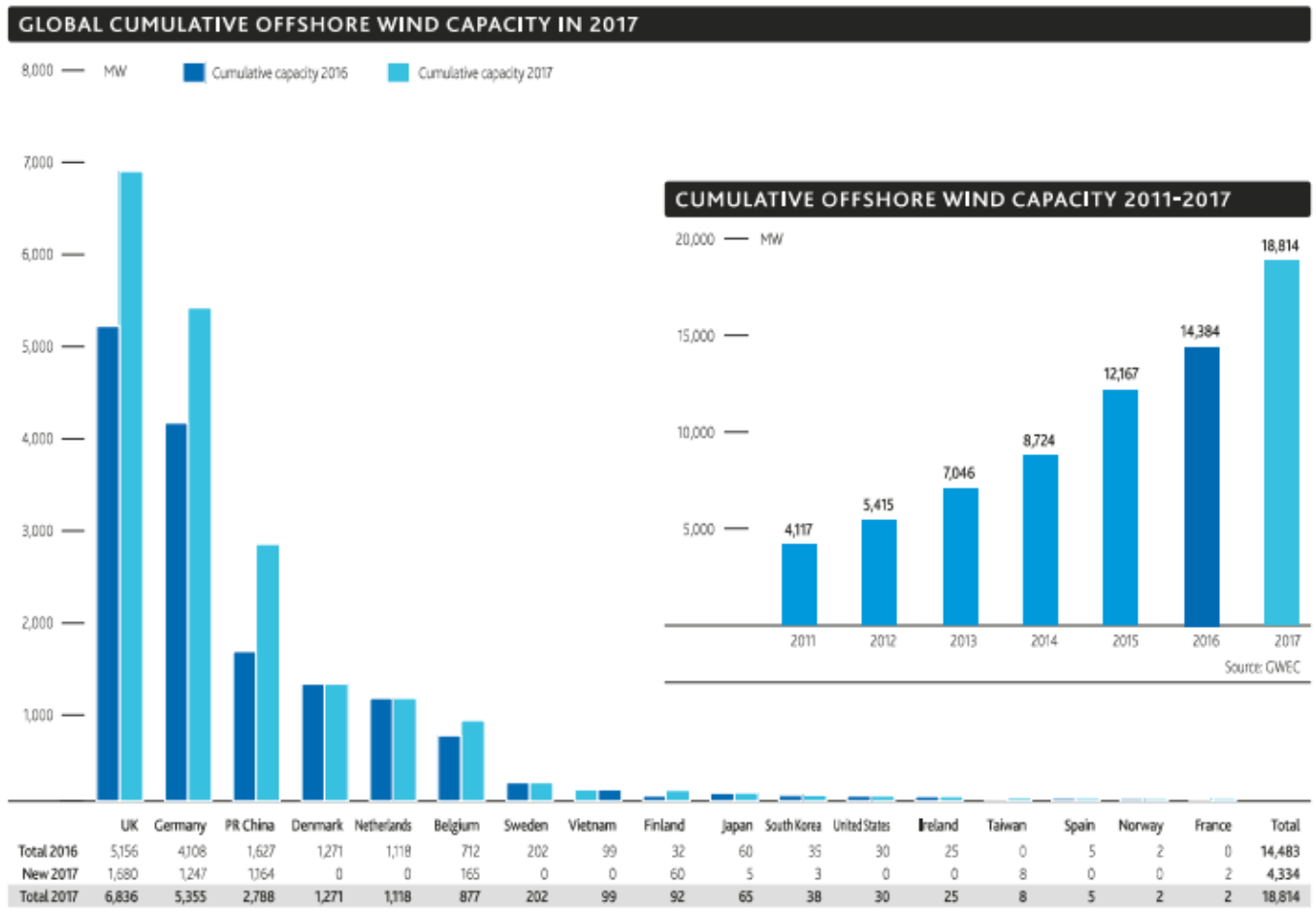

Figure 1 Global Cumulative Offshore Wind Installed Capacity in 2017 (Source GWEC)

## U.S. Market Overview

After many false starts, the U.S. took its first steps into the Offshore wind sector. In fall 2016, the Block Island Wind Farm located off Rhode Island and owned by Deepwater Wind marked a milestone as the first commercial offshore wind project in the United States. The 30MW project off the southern coast of Block Island. It is comprised of five 6-MW Haliade wind turbines manufactured by General Electric (formerly Alstom Wind Power) and is expected to produce enough electricity to power 17,000 Rhode Island homes (Chesto 2017). The development also connects Block Island to the mainland grid and negates the requirement of a diesel generator for the population of Block Island itself.

## Offshore Wind Farm Components

There is no single way to build and operate an offshore wind farm, and indeed the challenges of scale, water depth and distance from shore are such, that the optimal solutions are still being developed.

The pace of innovation in the wind industry has been unprecedented by any standards over the past decade where we have seen the scale alone range from 2MW to 10MW turbines with further growth to 15MW expected in the very near future (early 2020's). With increased scale of turbines come opportunity for cost reduction and optimization, however, it does not come without challenges in areas such as installation as these turbines will be pushing, and in some cases, exceeding the limits of some of the largest installation vessels in the world.

Below is a high-level overview of the key components of an Offshore Wind Farm:

- > **Wind Turbine Generator ("WTG"):** The wind turbine generator is the device that consist of a drive train, nacelle, hub, tower and blades and converts the wind energy to electrical energy via the mechanical movement of the blades on the turbine. For offshore wind, the scale of the offshore turbines is considerably larger than their onshore relation.
- > **WTG Foundations and Substructures:** These are the structures that support the offshore WTG. These support structures can be either fixed or floating and can be manufactured from steel or concrete. Fixed bottom substructures such as monopiles and jackets are the leading choice of developers to date. The early offshore wind developments were relatively near to shore, located in shallow water, and therefore best suited fixed bottom solutions such as monopiles. As the projects became bigger, further offshore and developments moved into more transitional waters (typically 30m to 60m water depths) the industry has seen the introduction of jacket substructures.



Offshore wind farm

Alternatives to the jackets and monopiles concepts such as gravity base, tripods, suction bucket and hybrid solutions have also entered the market in recent years.

- > **Inter Array Cables:** these are the electrical cables (i.e. collector system) which connect the turbines offshore. The majority of global offshore wind sites to date have been 33kV (U.S. development Block Island has 34.5kV), however benefits to transmitting at a higher voltage are now being recognized, and we have recently seen installation of 66kV inter array projects in Europe.
- > **Offshore Substation Platform ("OSP")/Offshore Substation Structure ("OSS"):** The OSP or OSS as it is known in some regions collects the power from the windfarm and transmits it back to the onshore substation for connection to the grid. Depending on the proximity of the offshore Wind farm these may be High Voltage Alternative Current ("HVAC") or High Voltage Direct Current ("HVDC").

- > **Export Cable:** Power from the wind farm is exported from the offshore substation via one or a number of undersea high voltage cables, which on making landfall transition from an underwater "wet" cable to a "dry" land cable, where it continues to the onshore substation.
- > **Onshore Substation:** This is the land connection point from the offshore substation, where the power is received and then transferred to the grid.

The offshore wind sector is expected to grow quickly over the next decade, boosted by a predicted

**\$300 BILLION INVESTMENT** that will add an approximate 10GW to the nation's current wind energy capacity

Figure 3 Typical Wind Farm Overview

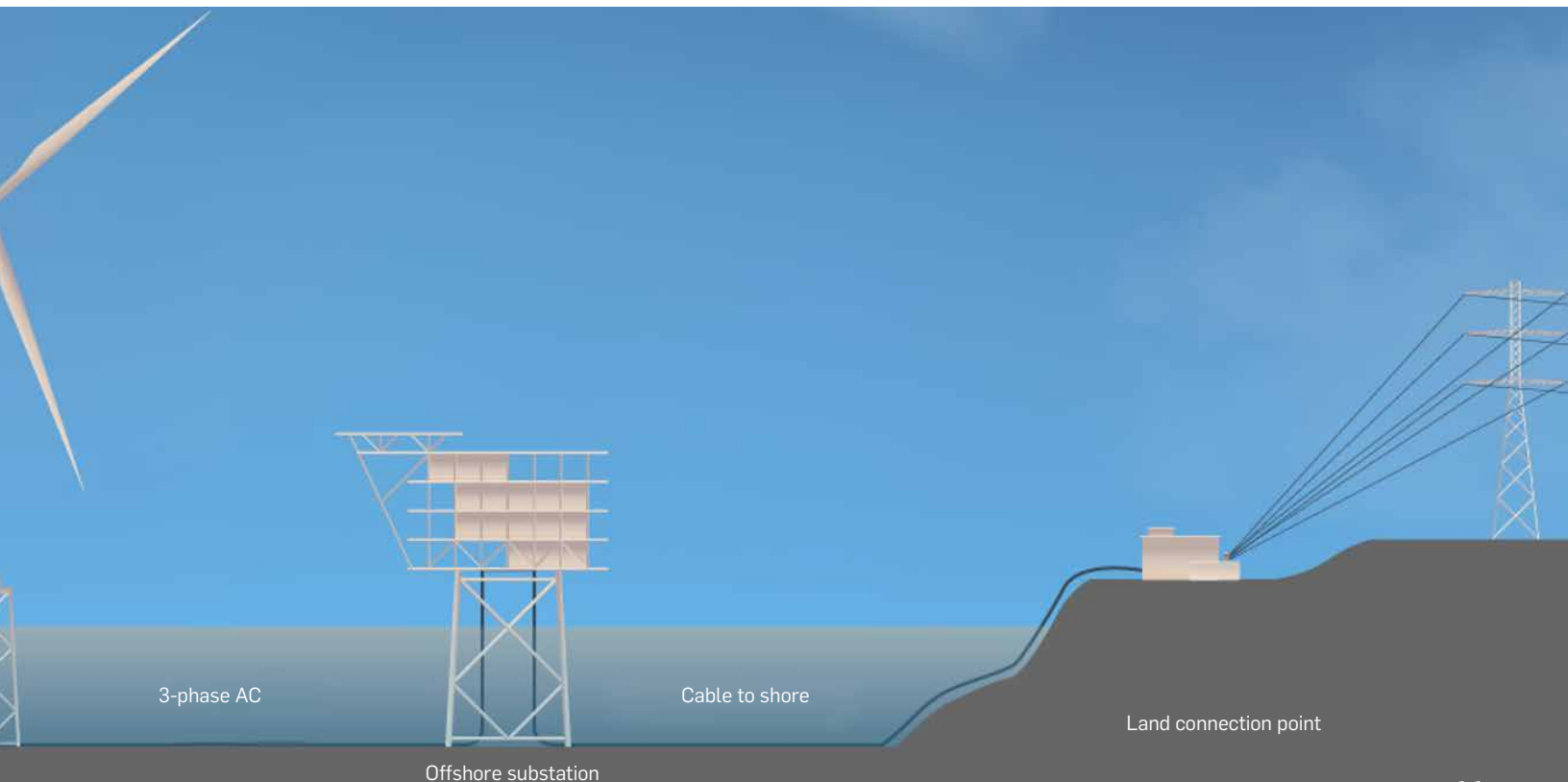



*Block Island Offshore Wind Farm  
— Courtesy of Deepwater Wind*

# Laws and Regulations Shaping Offshore Wind Development

## U.S. Federal Offshore Policy and Regulatory Issues

AUTHORS: **David Wochner and Ankur Tohan,**

K&L Gates

### U.S. Federal Offshore Policy

A complex framework of laws and regulations shape the scope, scale and structure of offshore wind power development in the United States. Federal laws are the primary legal regime governing project development, with state and local laws contributing significantly depending on where a particular project is located and how state regulators interact with their federal counterparts. This chapter provides an overview of the regulatory landscape that offshore wind developers should evaluate as they execute on a development plan.

For decades, the U.S. offshore has been the domain of oil and gas exploration and production. Recognizing the significant opportunity to develop other offshore resources within federal jurisdiction, Congress included in the Energy Policy Act of 2005, (EPAAct 2005) an amendment to the existing Outer Continental Shelf Lands Act (OCSLA) (43 U.S.C. § 1331 et seq.) attempting to clarify the federal government's role in citing offshore renewable energy facilities, including offshore wind power. Specifically, Section 388 of EPAAct 2005 gave the U.S. Secretary of the Interior, in coordination with other agencies, authority over offshore renewable energy facilities on the outer continental shelf ("OCS").

The Secretary's authority is implemented by the Interior Department's Bureau of Ocean Energy Management (BOEM) through a robust set of offshore renewable energy regulations and siting guidance. See 30 CFR

Part 585. BOEM issued the final regulations establishing the offshore renewable energy program in 2009, and after a halting start due to the global financial crisis, the Obama Administration reinvigorated the program by holding a number of new lease sales near the end of the administration. Through September 2018, BOEM has made more than 1.18 million acres of submerged federal land on the OCS available for potential wind power development, which has generated over \$16.4 million in federal revenue through competitive auctions for offshore leases.

The candidacy and election of Donald Trump in November 2016, injected significant uncertainty into the future of offshore wind given statements made against offshore wind by candidate Trump during the campaign. In what is a strong, positive development for the offshore wind power industry, however, the Trump Administration has advocated consistently for offshore wind as an important part of an "all-of-the-above" energy strategy. Significantly, the Interior Department, led by Secretary Ryan Zinke, has moved forward with two offshore wind lease sales off the coast of Massachusetts, has requested industry input regarding interest in offshore wind power between New York and New Jersey, and is conducting a high-level assessment of all waters off the U.S. East Coast for potential additional lease locations. Cooperation between the Interior Department and state and local agencies continue to help move projects forward, like the proposed Redwood Coast Energy Authority in northern California.

The significant investment and infrastructure required to develop offshore wind projects is consistent with President Trump's focus on major infrastructure initiatives and there appears to be an increasing appetite in the capital markets on opportunities to move projects

forward. But concerns remain regarding obstacles to developing offshore wind projects on the OCS, including the stability of federal tax credits, the complexity and length of the federal regulatory review process, and untested legal issues related to the intersection of federal-state jurisdiction. Environmental opposition also will be an issue for offshore wind projects, despite the "clean energy" moniker. As the industry moves forward, resolving these issues will be critical to ensure the advancement of the industry.

## Bureau of Ocean Energy Management ("BOEM")

EPAAct 2005 authorized the Secretary of the Interior, in consultation with other federal agencies, to grant leases, easements, or rights-of-way on the OCS and a subsequent memorandum of understanding with the U.S. Federal Energy Regulatory Commission ("FERC") confirmed the exclusive jurisdiction of the Interior Department over "the production, transportation, or transmission of energy from [non-tidal] renewable energy projects on the OCS including offshore wind power. Through delegation from the Secretary of the Interior, BOEM is the main federal agency responsible for managing energy development on the OCS, for both traditional energy resources and renewable energy projects, including the siting and operation of offshore wind facilities. Importantly, EPAAct 2005 clarified that the Secretary of the Interior's siting authority has no effect on existing authority or responsibilities of other federal or state agencies acting pursuant to other federal laws. Thus, as explained further below, a wide range of federal and state agencies remain key contributors to the Interior process for the siting and operation of offshore wind power facilities, in particular those agencies acting pursuant to the National Environmental Policy Act, ("NEPA").

BOEM discharges its responsibility for renewable energy project development on the OCS via its leasing process outlined in the Code of Federal Relations at 30 C.F.R. Part 585. Since those regulations were passed, BOEM has received strong interest in offshore renewable energy

projects. In response, BOEM currently works closely with several states regarding offshore energy development and is coordinating federal-state task forces in certain coastal states. A summary of the status of activity in the different states can be found at <https://www.boem.gov/Renewable-Energy-State-Activities/>. BOEM's OCS work and interaction with other federal statutes is outlined in more detail below.

## Key Components of BOEM Regulatory Process

### a) Planning and Leasing

The Planning and Leasing phases are the foundation of the regulatory program for offshore wind development. BOEM undertakes several initiatives to determine whether there is interest in particular OCS areas for offshore wind development, and if there is interest, to move toward leasing those areas for development. BOEM can undertake activities on its own initiative, issuing Requests for Information (RFI); Calls for Information and Nominations; identifying priority Wind Energy Areas (WEAs), offshore areas that are most appropriate for offshore wind energy development; and preparing an environmental assessment in preparation for a lease issuance. BOEM also can receive unsolicited applications submitted by offshore wind power project developers interested in particular offshore areas. A major feature of the Planning phase is establishing an Intergovernmental Task Force for any identified WEAs to ensure that all stakeholders with relevant expertise, including state and sometimes local governmental authorities, are engaged with BOEM from early in the process. Such initiatives can take two years or more given the significant coordination and timing involved.

Leasing offshore federal lands is the heart of BOEM's jurisdiction. EPAAct 2005 made clear that any lease issued for an offshore renewable energy development must be done on a competitive basis. As a result, BOEM first determines whether "Competitive Interest" exists for the proposed lease area, usually through the issuance of a Request for Interest. If a competitive interest exists for a potential lease area, BOEM then publishes a Call for Information and Nominations for leasing in that particular

area. As part of the process for identifying lease areas or WEAs, and before holding any auction, BOEM must conduct an environmental review and assessment under NEPA (outlined further below).

Based on information received and its own assessment, BOEM may then move forward with an auction by publishing a Proposed Sale Notice for the identified lease areas. BOEM has detailed regulations addressing the possible formats that BOEM can use (e.g., sealed bidding or multi-factor bidding) for an auction as well as the bidding systems that the agency will employ in evaluating bids (e.g., cash bonus with a constant fee rate or sliding operating fee rate with a fixed cash bonus) (30 CFR §§ 585.220 -.225).

If the auction results in a lease, the lessee receives access and operational rights to produce, sell and deliver renewable energy generated from the facilities on the OCS in the lease area, albeit over phased lease terms described further below. Importantly, the lessee cannot begin construction at this point, as there are a number of other critical steps that the project developer must achieve.

#### **b) Site Assessment Plan ("SAP") and Construction and Operation Plan ("COP")**

Once a project developer secures a lease, it moves into the third phase, the Site Assessment phase. The purpose of this phase is to allow the lessee to engage in activities on the leased land to assess the actual wind resources and better understand the conditions of the lease area. Specifically, the lessee is required to submit within 12 months a Site Assessment Plan ("SAP") (or a combined SAP and Construction & Operation Plan ("COP")) to the agency describing how the lessee will conduct its assessment activities and technology testing on the OCS. BOEM will review and evaluate the SAP, including conducting its own environmental and technical review, and ultimately deciding whether to approve, disapprove, or approve with conditions (most common) the "SAP".

Once BOEM approves the SAP, the lessee will have a five-year lease term to engage in the site assessment activities and during that five-year period also must submit its COP (if it was not already submitted jointly with its SAP). The COP is the key document in which the lessee outlines the construction and operation of a wind power project on the OCS under the federal lease. Along with the construction and operation of the facility, the document must also include decommissioning plans when the lease ends. Similar to the SAP, BOEM will conduct its own environmental and technical reviews of the COP, including an evaluation of reasonable project alternatives; in addition, the agency will solicit public comment before ultimately deciding whether to approve, with conditions, or disapprove the COP.

If BOEM approves the COP, then the project developer typically would be granted a 25-year commercial lease, effective on the date of COP approval, with the possibility of renewal beyond the initial 25 years.

Regarding any infrastructure required for the transmission of the energy generated from the offshore wind facilities to shore, the lease terms usually will include the grant of one or more easements to install cables, pipelines, and other appurtenances on the OCS as necessary to transmit the power to shore. Lessees should request one or more such easement(s) when they submit a COP for approval. BOEM's approval of the COP will include the grant of the associated rights-of-way.

BOEM's process is lengthy and requires substantial, continuous and effective engagement by the project developers. While familiarity with the regulations is important, the agency does have some degree of discretion so flexibility and adaptability is also required. Historically, offshore wind power developers could expect to spend 7-10 years in the planning and construction process before commercial operations of the installed offshore wind facilities actually commence.

## Major Components of Federal Environmental Review Process

### a) National Environmental Policy Act (“NEPA”)

Passed in 1969, NEPA (42 U.S.C. §§ 4321-4347) is the foundation of environmental policymaking in the United States. The NEPA process is designed to help public officials make decisions based on complete understanding of environmental consequences and take actions that protect, restore, and enhance the environment. Depending on the type of project, a NEPA analysis may include one or more of the following:

1. Environmental Assessment (EA)
2. Finding of No Significant Impact (FONSI)
3. Environmental Impact Statement (EIS)
4. Cumulative Impact Analysis
5. Global Climate Change
6. Transboundary Environmental Impact

NEPA established the Council on Environmental Quality (CEQ) to advise agencies on the environmental decision-making process and to oversee and coordinate the development of federal environmental policy. In 1978, the CEQ issued regulations (40 C.F.R. §§ 1500-1508) implementing NEPA. These regulations include procedures for federal agencies to follow during the environmental review process.

In August 2017, DOI issued Order No. 3355 to implement Executive Order 13807 and other NEPA improvements. The Executive Order directs federal agencies to use a single, coordinated process for NEPA compliance, including preparation of a single EIS and Record of Decision (ROD), directs that the NEPA process be completed within an average of two years, and directs that all federal permits for the project approved in the ROD be issued within 90 days after issuance of the ROD. In Order No. 3355, the DOI limited a NEPA EIS to 150 pages, or 300 pages for unusually complex projects, excluding appendices. This contrasts sharply with prior

practice, where EISs could routinely stretch for 2,000 or more pages. This rule will apply to any EIS for OCS offshore wind projects going forward.

### b) Endangered Species Act (“ESA”)

Passed in 1973, the ESA (16 U.S.C. § 1531 et seq.) is intended to conserve endangered and threatened species and their habitats. There are approximately 1,930 species listed under the ESA that are found in part or entirely within the United States and its waters. The National Oceanic and Atmospheric Administration's National Marine Fisheries Service (NMFS) and the Department of the Interior's U.S. Fish and Wildlife Service (USFWS) share responsibility for implementing the ESA, with NMFS generally managing marine and anadromous species and USFWS managing land and freshwater species. While the USFWS has guidance in place for land-based wind energy development<sup>1</sup> (available at [https://www.fws.gov/ecological-services/es-library/pdfs/WEG\\_final.pdf](https://www.fws.gov/ecological-services/es-library/pdfs/WEG_final.pdf)) it does not have policies in place for offshore wind development.

Section 7 of the ESA mandates that BOEM and all other Federal Agencies consult with the Secretary of Commerce (via NMFS) and/or Interior (via USFWS) to ensure that any “agency action” is not likely to jeopardize the continued existence of any endangered or threatened species, or result in the destruction or adverse modification of an endangered or threatened species' critical habitat. The consultation process begins when BOEM provides NMFS and/or USFWS with details on the proposed activity, the ESA-listed species and designated critical habitat in the area, the best available information on effects to species and habitats from the proposed action, and measures that will be required by BOEM to reduce or eliminate the potential for effects to occur (e.g., mitigation and monitoring measures). Formal consultation must occur for any activity that BOEM, NMFS, or USFWS determines may adversely affect listed species or designated critical habitat.

<sup>1</sup> In addition, the USFWS has published similar guidance for wind energy developers whose projects may incidentally take bald or golden eagles. See Eagle Conservation Plan Guidance, Module 1— Land Based Wind Energy, Version 2.



Once initiated, the consultation process ends with finding that there is no likelihood of an adverse effect on a listed species, or in the issuance of a biological opinion by NMFS and/or USFWS. This opinion documents whether the action BOEM proposes to authorize is likely to jeopardize listed species or adversely modify critical habitat. It may also provide an exemption for the taking of listed species and may outline measures deemed necessary to minimize impacts. After completing the consultation process, BOEM will determine whether to authorize the proposed activity.

If authorized, BOEM will require the lessee to implement needed mitigation measures identified during the consultation process, in addition to, monitoring measures meant to detect taking or adverse effects. BOEM will also evaluate the effectiveness of these mitigation and monitoring measures to reduce effects.

### c) Migratory Bird Treaty Act (MBTA)

Passed in 1918, the MBTA implements the United States' commitment to four bilateral treaties, or conventions, for the protection of a shared migratory bird resource. The original treaty upon which the MBTA was passed was the Convention for the protection of Migratory Birds signed with Great Britain in 1916 on behalf of Canada for the protection "of the many species of birds that traverse certain parts of the United States and Canada in their annual migration." The primary motivation for negotiation of the 1916 treaty and the passage of the MBTA was to stop the "indiscriminate slaughter" of migratory birds by market hunters and others.

The MBTA was subsequently amended as additional treaties were signed with Mexico (1936, amended 1972 and 1999), Japan (1972), and Russia (1976). The Canadian treaty was amended in December 1995 to allow traditional subsistence hunting of migratory birds. Each of the treaties protects selected species of birds and provides for closed and open seasons for hunting game birds. By implementing the four treaties within the

United States, the MBTA protects over 800 species of birds. The list of migratory bird species protected by the MBTA appears in Title 50, section 10.13, of the Code of Federal Regulations (50 C.F.R § 10.13).

Under the MBTA, it is unlawful to pursue, hunt, take, capture, kill, possess, sell, purchase, barter, import, export, or transport any migratory bird, or any part, nest, or egg or any such bird, unless authorized under a permit issued by the Secretary of the Interior. Some regulatory exceptions apply. There are no incidental take permits available for off shore wind projects under the MBTA.<sup>2</sup>

In 2009, BOEM (then MMS) entered into a Memorandum of Understanding (MOU) with USFWS to "strengthen migratory bird conservation through enhanced collaboration between the MMS and the FWS." In assessing impacts to and protecting biological resources, BOEM consults with the USFWS on activities that may affect threatened and endangered species. BOEM also evaluates the effects on migratory birds and important habitats such as offshore and nearshore foraging, staging, molting, and roosting habitats.

BOEM regularly conducts studies that provide information for protection and conservation of migratory birds, including protected species. BOEM uses the NEPA process to evaluate potential impacts of proposed actions and alternatives, including impacts to migratory birds and their habitats. The potential impacts on migratory birds associated with offshore wind development may include direct effects such as the possibility of attraction to and collision with structures. For example, large numbers of migratory birds have been observed to be attracted to offshore structures and should be evaluated due to potential for collision. Indirect effects may include potential habitat loss through displacement or disturbance. In addition, accidents, such as oil spills, can have short-term, acute and long-term, chronic effects on migratory birds and their habitats.

<sup>2</sup> Take is defined in regulations as: "pursue, hunt, shoot, wound, kill, trap, capture, or collect, or attempt to pursue, hunt, shoot, wound, kill, trap, capture, or collect." 50 C.F.R § 10.12.

#### d) Coastal Zone Management Act ("CZMA")

In 1972, Congress enacted the CZMA (16 U.S.C. § 1451 et seq.) to protect the coastal environment from impacts of residential, recreational, commercial, and industrial uses. The CZMA helps states develop coastal management programs that manage and balance competing uses of the coastal zone. Thirty-five state and territories participate in the CZMA. A full list with description of each state's program is available here: <https://coast.noaa.gov/czm/mystate/>. Alaska withdrew from the CZMA on July 1, 2011, making it the only coastal or Great Lakes state to not participate. In each state, the program is implemented by one or more state agencies, usually the Department of Natural Resources, primary environmental agency, or primary coastal management agency.

Federal agencies, including BOEM, must follow the federal consistency provisions of the CZMA, set forth in 15 C.F.R. Part 930. The federal consistency provisions require federal actions that are reasonably likely to affect land or water use of the coastal zone, to be consistent with enforceable policies of a state's coastal management plan. Different subparts provide guidelines for different types of activities: Subpart C deals with federal agency activities, Subpart D deals with private activities requiring federal licenses or permits, Subpart E deals with OCS exploration, development and production activities, and Subpart F deals with federal assistance to state and local governments.

States can review OCS lease sales for federal consistency. In these cases, BOEM produces a "consistency determination" that describes how the sale is consistent "to the maximum extent practicable" with the Program's enforceable policies. BOEM then sends a copy to each affected State for review. The State has a designated time period during which to agree or disagree with the consistency determination. If the State agrees, the lease sale can proceed. If the State disagrees, it must describe the inconsistency and any alternative measures that would allow the sale to be consistent. BOEM tries to resolve any potential problems with the State, but the CZMA does allow BOEM to proceed with the lease sale regardless. BOEM can also seek NOAA mediation.

States can also review OCS exploration and development and production plans. In this case, the OCS lessee prepares a "consistency certification" and "necessary data and information" along with the proposed plan. BOEM then sends a copy of the Plan and CZM information to the affected State's coastal agency for federal consistency review and decision. The State must concur, with or object to the lessee's consistency certification within a designated time period. If the State fails to meet the deadline, the plan is conclusively presumed and thus approved. If the State concurs, BOEM approves the plan. If the State objects to an Exploration Plan, BOEM can approve the plan but cannot issue permits. If the State objects to a development or production plan, BOEM cannot approve the plan and the lessee can either choose to appeal the State's decision to the Department of Commerce or amend and resubmit it. The review process is nearly identical for OCS permits.

The National Renewable Energy Laboratory (NREL) estimates

THE TECHNICAL  
RESOURCE POTENTIAL FOR  
U.S. OFFSHORE WIND IS IN  
EXCESS OF 2,000 GW

# State Offshore Policy and Regulatory Issues

AUTHORS: **Buck Endemann and Michael O’Neill,**  
K&L Gates

## Massachusetts

Massachusetts has been an early mover in the offshore wind space, but its progress has been mixed. The 468-MW Cape Wind project offshore Martha’s Vineyard received its BOEM lease in 2010, the first federal offshore wind commercial lease in the United States. But the project encountered substantial opposition from local stakeholders. National Grid and NStar terminated their PPAs with the project 2015. The project is dead as the project has surrendered its BOEM lease.

Massachusetts restarted the push for offshore wind with a 2016 statute that encourages utilities to procure up to 1,600 MW of offshore wind by 2027. In 2017 and 2018, Massachusetts utilities and MA DOER conducted a solicitation process for long-term contracts for up to

800 MW of offshore wind proposals. On May 23, 2018, the utilities and DOER selected the Vineyard Wind project, an 800-MW project jointly developed by Avangrid and Copenhagen Infrastructure Partners, as the winner of this so-called 83C RFP process. Vineyard Wind’s goal is to begin commercial operations in 2021.

Massachusetts is also working with Rhode Island to develop 1,200 MW of offshore wind capacity for the region. Massachusetts’ contribution is the 800-MW Vineyard Wind project. Rhode Island’s project is Deepwater Wind’s 400-MW Revolution Wind (see below re Rhode Island).

## Maine

Maine began focusing on offshore wind development in earnest with the 2010 Ocean Energy Act. But like Massachusetts, Maine has seen progress in fits and starts. In 2013, Statoil (now Equinor) canceled plans to build an offshore wind pilot project. There are no current proposals for offshore wind projects on federal OCS lands at this time.



Construction of a Nacelle—Courtesy of Ørsted

The Maine Aqua Ventus project, a public-private partnership including the University of Maine, proposes a 12-MW pilot project (two 6-MW floating turbines) for a site south of Monhegan Island that will support a 20-year PPA. However, the terms of the PPA remain pending before the Maine PUC. On June 12, 2018, the PUC reopened its review of a 2014 term sheet that will form the basis of the project's PPA. The PUC argues that changed circumstances in the energy sector, including low-cost natural gas, encouraged this reopening. The PUC is requesting additional information regarding the Aqua Ventus project in order to inform its reconsideration of the project.

## Maryland

Maryland has begun to encourage offshore wind development with the Offshore Wind Energy Act of 2013. This statute permits wind project developers to receive financial support for their projects in the form of Offshore Wind Renewable Energy Credits (ORECs). The statute also amended the state's RPS to include offshore wind projects within 10-30 miles off the Maryland coast.

The Maryland PSC has approved OREC eligibility for two projects: U.S. Wind and Skipjack Offshore Energy (Deepwater Wind), with a number of conditions.

- > **U.S. Wind:** 250-MW project with 32 turbines approximately 17 miles offshore Ocean City, Maryland, with a goal of 2021 for commercial operations. U.S. Wind executed two commercial leases for wind projects with BOEM on December 1, 2014 (BOEM and U.S. Wind merged into these leases into a single agreement). The project might install up to 187 turbines offshore Maryland.
- > **Skipjack Offshore Energy:** 120-MW project approximately 19.5 miles offshore Maryland and 26 miles from the Ocean City Pier, with a commercial operations date of 2022. Skipjack Offshore has a lease with BOEM after receiving an assignment of a portion of the GSOE I, LLC lease.

## New Jersey

New Jersey is seeking to accelerate its participation in the offshore wind sector. Governor Phil Murphy signed an executive order directing state agencies, including the New Jersey BPU, to move towards deploying 3,500 MW of offshore wind energy projects by 2030. After establishing an OREC pricing plan, the BPU must solicit 1,100 MW worth of offshore wind projects.

The BPU is implementing the terms of the executive order, and recently convened a meeting of stakeholders to discuss the solicitation process. Media reports indicate that there is uncertainty regarding the structure of the bidding process, as developers want to develop both the offshore wind turbine generation as well as the project-to-shore transmission projects. However, transmission developers have objected to being left out of the bidding process.

- > **Ocean Wind:** Ørsted is developing Ocean Wind following an assignment of RES America Developments' BOEM lease. BOEM has approved the Site Assessment plan for Ocean Wind and authorized the placement of three buoys on the proposed OCS wind farm site. Ørsted has also opened an office in Atlantic City.
- > **Garden State Offshore Energy:** GSOE (Deepwater Wind and PSEG) is developing the northern portion of the lease area that it partially assigned to Skipjack offshore Delaware. GSOE proposes a 350-MW offshore wind project approximately 20 miles due east of Avalon, New Jersey. The BPU awarded \$4 million to GSOE in 2008 to develop the project, but construction has not begun to date.

## Rhode Island

Rhode Island is a leading jurisdiction for offshore wind energy developing, boasting the United States' first operational offshore wind project at Block Island. Rhode Island has also selected Deepwater Wind's Revolution Wind to build a separate offshore wind farm. Development of the Rhode Island offshore wind sector grew from a 2009 state statute that remade Rhode Island's RPS program and required that the state's utility, National Grid, enter into long-term contracts with a

10-MW offshore wind demonstration project at Block Island and a second 150-MW utility scale offshore wind project if the demonstration project was successful.

- > **Block Island:** Deepwater Wind developed and deployed the first offshore wind farm in the United States, a 30-MW project with five turbines. The project entered commercial operation on December 12, 2016. The project is located in state waters, although the transmission line from the turbines to the shore crosses BOEM OCS lands and required federal approval of an ROW grant. Deepwater Wind assigned the ROW grant to The Narragansett Electric Co. in January 2015.
- > **Revolution Wind:** Rhode Island has selected the 400-MW version of Deepwater Wind's Revolution Wind proposal as a non-public part of Massachusetts 83C procurement process. Massachusetts ran the process and Rhode Island cooperated, making a surprise selection of the Revolution Wind project. The project will be located in federal waters at lease area OCS-A-0486.

## Connecticut

Connecticut's Department of Energy & Environmental Protection (DEEP) conducted an RFP process from January to April 2018 soliciting renewable energy projects, including up to 825,000 MWh (annually). On June 13, 2018, Connecticut selected a 200-MW portion of Deepwater Wind's Revolution Wind project (separate from the 400-MW portion of Revolution Wind that Rhode Island selected). Under the RFP process, Deepwater Wind will now negotiate a PPA with the state's utilities, Eversource and United Illuminating. The utilities expect to submit the PPA to the Connecticut Public Utilities Regulatory Authority for approval in October 2018.

Deepwater Wind also committed to a suite of investment projects in Connecticut, including \$15M to refurbish part of the Port of New London and a research partnership with UConn at Avery Point.

## New York

New York PSC issued an order on July 12, 2018, establishing a framework for procuring offshore wind energy. The framework follows on NYSERDA's New York State Offshore Wind Master Plan of January 2018. The Master Plan proposes to install 2,400 MW of offshore wind capacity by 2030, noting declining costs and other benefits. The PSC determined to add offshore wind generation to the overall Clean Energy Standard and adopted the ultimate goal of 2,400 MW by 2030, with 800 MW for the initial procurement in 2018 and 2019.

The PSC also proposes the procurement of ORECS for the 800 MW capacity and directs the state's Load Serving Entities to submit standard OREC agreements to NYSERDA by March 31, 2019.

NYSERDA requested public comments by August 10, 2018, via an RFI regarding the agency's plans to issue a competitive RFP solicitation. NYSERDA plans to issue the first solicitation in Q4 2018, but seeks additional public input regarding numerous other topics.

Equinor (Statoil) secured the initial lease on OCS lands from BOEM in March 2017 and has designated the project Empire Wind. The lease site could support between 1,000-1,500 MW of electricity capacity on 80,000 acres approximately 20 miles south of Long Island and east of the Rockaways. Empire Wind is developing a Site Assessment Plan to submit to BOEM.

PNE Wind filed an unsolicited wind lease bid application with BOEM on December 30, 2016. BOEM is evaluating the application and, if the agency decides to move forward, may issue a public notice to determine whether there is competitive interest bidding in the area.

## Virginia

In 2010, Virginia established the Virginia Offshore Wind Development Authority. The agency is tasked with coordinating and supporting the development of the offshore wind energy industry, supporting project developers and equipment vendors.

A consulting firm prepared an evaluation of the readiness of Virginia's ports to support the offshore wind sector.

Dominion's Coastal Virginia Offshore Wind has agreed with Ørsted to develop a small research wind project offshore Virginia Beach (two turbines for 12 MW in total). The target installation date is 2020.

Dominion also secured an OCS lease from BOEM in 2013. BOEM approved Dominion's Site Assessment Plan in October 2017, including a floating resource assessment wind buoy.

BOEM has executed a series of cooperative agreements with Virginia and BOEM has approved the first wind energy research lease for Virginia.

## California

Compared to the eastern seaboard states, California offers new opportunities and challenges to developers and operators of offshore wind projects. In general, the waters off California tend to be deep and rocky, such that developers have envisioned using floating or tethered wind turbine technology to harness the significant wind resources in the central and northern parts of the state. California has also historically invested heavily in coastal transmission and substation infrastructure. Due to the retirement of several nuclear and once-through-cooling power plants, these assets are carrying less capacity and may facilitate cheap onshore transmission of wind power that is generated offshore.

The federal BOEM is generally responsible for regulating offshore wind development between 3 and 200 nautical miles offshore. Wind projects located within BOEM jurisdiction must undergo a competitive leasing process run by the federal government. With some carve-outs for

military and environmentally sensitive areas, California retains jurisdiction over the first three miles of water off its coastline. While few wind turbines will be sited that close to shore, any transmission or substation infrastructure within three miles of the coast requires a lease from the California State Lands Commission. Onshore or near-shore development related to the offshore project would trigger review by the California Coastal Commission. All state leasing and permitting decisions must comply with the California Environmental Quality Act (CEQA), which requires the lead government agency to identify any significant environmental impacts arising from the project. The project must incorporate feasible mitigation measures to mitigate those impacts to a level that is "less than significant." Based on our experience with onshore solar and wind development, we anticipate that CEQA's citizen-suit provisions will offer project opponents a powerful tool to block or modify projects they don't like.

California has an aggressive Renewable Portfolio Standard ("RPS") and may need a significant amount of new renewable generation to meet its goal of 50% RPS by 2030. To facilitate offshore wind development, California and BOEM have established the Intergovernmental Renewable Energy Task Force (Task Force), which is a partnership of state, local and tribal governments and federal agencies, to plan and consider competitive leasing issues for future offshore renewable energy development opportunities. The Task Force provides tools and mapping programs to assist offshore wind developers in site selection. The California Energy Commission has also opened docket 17-MISC-01 to accept comments and presentations from developers, trade groups, environmentalists, and others looking to shape California's offshore wind policy.

Due to significant air and sea naval operations in San Diego and Los Angeles, the U.S. Department of Defense has recommended that nearly all of Southern California be closed to offshore wind development. Environmental stakeholders are also concerned about the impact of wind development on marine sanctuaries around the Channel Islands. The area is also home to several busy ports. Negotiations continue among federal, state, and private actors.

Central and northern California show more promise for offshore wind development. In 2016, Trident Winds submitted a BOEM application to install 650–1,000 MW of turbines north of Morro Bay. That location has also drawn interest from Equinor, and BOEM is currently evaluating whether to award Trident Wind a license for development. Further north, in Humboldt County, Redwood Coast Energy Authority (a California Community Choice Aggregator) is considering a public-private partnership to develop 100–150 MW of offshore wind off the coast of Eureka.

## Hawaii

Hawaii has been an active state for evaluating and starting to develop offshore wind projects. The Hawaiian PUC approved the states' utilities' Power Supply Improvement Plan in 2017, the utility's plan to meet the state's goal of 100% renewable energy by 2045. The plan includes 800 MW of offshore wind generating capacity.

BOEM has received three unsolicited OCS wind lease applications:

1. Alpha Wind Oahu Northwest (400 MW)
2. Alpha Wind Oahu South (400 MW)
3. Progression Hawaii Offshore Wind (400 MW)

Equinor (Statoil) participated in BOEM's Call for Information and Nominations in September 2016, asserting its interest in the whole Oahu OCS Call Area.

BOEM has confirmed that it has received a fourth request to participate in a future offshore lease sale, but has not named the company yet. BOEM is evaluating the qualifications of the company to participate in the lease sale.

BOEM has and continues to evaluate the potential impacts of offshore renewable energy in the Pacific region, including Hawaii. NREL has examined future economic impacts of offshore wind in Hawaii.



*Hywind—Courtesy of Equinor*

# The Jones Act Maritime Law

AUTHORS: **William Myhre and Lindsey Greer,**  
K&L Gates

## What is the Jones Act?

The “Jones Act” generally refers to several provisions of U.S. law known as the coastwise laws that impose limitations on vessel operations in a number of ways that impact offshore wind projects. The coastwise laws apply not only to the transportation of passengers and merchandise between points in the United States and the Outer Continental Shelf (“OCS”), either directly or via a foreign port, but also impose certain limitations on towing, dredging and fishing activities in U.S. waters.

In order to qualify to engage in coastwise trade the vessel must:

- > be built in the United States (and have never been rebuilt abroad);
- > be owned and controlled by citizens of the United States;
- > have primarily a U.S. citizen crew, and
- > have a Certificate of Documentation with a coastwise endorsement issued by the U.S. Coast Guard.

Under the Jones Act merchandise is broadly defined to include almost any type of cargo including “goods, wares, and chattels of every description” as well as “valueless material”. A passenger is any person carried on a vessel who is not connected with the operation and navigation of the vessel, or the ownership or business of the vessel.

In order to qualify as a U.S. owner, the corporation or owning entity, must be organized under the laws of the U.S., and the Chief Executive Officer, by whatever title, and the Chairman of the Board, as well as a majority of the Board of Directors, must be U.S. citizens, and at least 75% of the equity in the entity must be owned and controlled by U.S. citizens.

The coastwise trade laws known as the “Jones Act” are codified in Chapter 551 of Title 46 of the U.S. Code.

Other federal laws that provide injured seamen a cause of action against their employer are also known as the “Jones Act” or the “Personal Injury Jones Act” and are codified in Chapter 301 of Title 46 of the U.S. Code.

## Application of the Jones Act to Offshore Wind Projects

The coastwise laws generally apply to points in the territorial sea, which is defined as the belt, three nautical miles wide, seaward of the territorial sea baseline, and to points located in internal waters, landward of the territorial sea baseline. The Outer Continental Shelf Lands Act (“OCSLA”) established the legal regime for the exploration, development and production of energy resources on the OCS.

OCSLA expressly extended the laws and civil and political jurisdiction of the United States, including the coastwise laws, to the subsoil and seabed of the OCS and to “all artificial islands, and all installations and other devices permanently or temporarily attached to the seabed which may be erected thereon for the purpose of exploring for, developing, or producing resources therefrom”. The Department of Interior has interpreted this extension of jurisdiction to apply not only to oil and gas production and transmission but to renewable sources of energy as well.

Customs and Border Protection (CBP) is the agency responsible for interpreting the coastwise laws and issues rulings on a variety of operating scenarios. These rulings are limited to the particular facts of the specific case, but provide helpful guidance in navigating the applicable requirements for the construction and maintenance of offshore wind projects.

For example, in connection with the construction of meteorological data towers outside the territorial sea and on the OCS to be used in collecting wind speed data useful in determining the site for future wind farm development, CBP ruled that the transportation of construction materials or passengers from a point in the United States to the construction vessel installing the wind tower requires a coastwise qualified vessel. The construction vessel, however, can be foreign flag as long as it remains stationary and does not transport anything



between points on the OCS or points in the U.S. and the territorial sea. Neither the drilling nor the pile driving by the stationary construction vessel constitutes coastwise trade.

In a subsequent ruling, CBP addressed the transportation and installation of two wind farms, one three miles off of Rhode Island, and the second some twenty miles off the coast. Some turbines were transported to their respective construction sites from Rhode Island on coastwise qualified vessels, whereas others were transported from Germany on non-coastwise qualified vessels. The turbines were installed by a stationary foreign-flagged jack-up vessel, with its legs securing it to the seabed, and using its cranes to lift the turbines from the transport vessel and placing them directly on to the steel jacket foundation at the project site. Although the crane on the jack-up vessel moved the turbines, the jack-up vessel itself remained stationary and thus there was no violation of the coastwise laws. At no time did the jack-up vessel transport merchandise or passengers between any of the installation sites.

Vessels used to conduct maintenance on completed wind turbines will need to be coastwise qualified, as do vessels that may be engaged in related dredging activities, or the towing of other vessels. There are certain related activities that can be conducted on foreign flag vessels, such as cable laying and pipe laying on the OCS or within territorial waters, as well as vessels engaged in research activities.

Advance CBP rulings are available should there be any question about compliance with the coastwise laws in connection with an offshore wind project. This is particularly advisable given the significant penalties for violations. The penalty for transportation of merchandise on a non-coastwise vessel is forfeiture of the merchandise so transported, or the value thereof. Transportation of passengers in violation of the coastwise laws is \$778 per passenger so transported. In addition, there are daily civil penalties for vessels operating in violation of the Coast Guard documentation regulations, as well as the potential seizure and forfeiture of the vessel and its equipment under certain circumstances.

The navigation laws, including the coastwise laws, can be waived by the Secretary of Homeland Security under very limited statutory authority when requested by the Secretary of Defense and only then to the extent considered necessary in the interest of national defense. Such waivers have been granted in connection with hurricane relief efforts, for example, and other extraordinary circumstances.

Occasionally Congress will enact special legislation authorizing issuance of a coastwise endorsement for a specific vessel that does not meet the requirements or has lost its qualification through foreign ownership or rebuilding, however such waiver requests are often controversial and infrequently enacted.

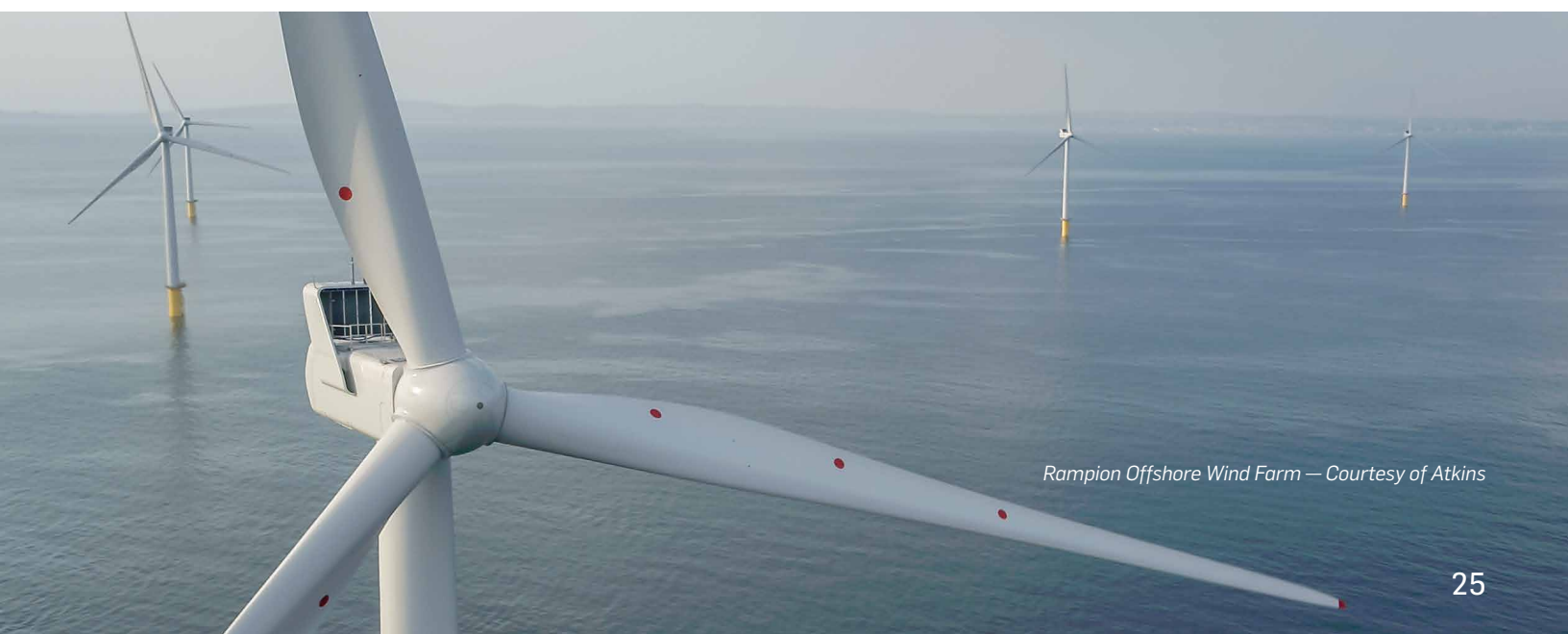

*Rampion Offshore Wind Farm — Courtesy of Atkins*

In addition to the “coastwise Jones Act” governing the transportation of merchandise, other federal maritime laws will apply to offshore projects including the “personal injury Jones Act” which gives seamen who were injured in

the course of their employment the right to sue their employer for personal injury damages, as well as the Longshore & Harbor Workers Compensation Act (“LHWCA”) and the Outer Continental Shelf Lands Act (“OCLSA”).

## MARITIME LAW

Question	Explanation
What is it?	<ul style="list-style-type: none"> <li>&gt; Consists primarily of national maritime laws of the U.S. and other countries, but includes some international conventions.</li> <li>&gt; Federal level: Congress passes federal maritime statutes. Federal courts decide maritime cases and can alter and expand the “federal common law” of maritime activity and commerce.</li> <li>&gt; Admiralty jurisdiction: Certain cases (e.g. claims directly against ships) can only be brought in federal “admiralty” court.</li> <li>&gt; State level: state courts can decide certain maritime cases but cannot create or alter federal maritime law.</li> </ul>
When does it apply?	<p>In the U.S., maritime law applies to:</p> <ul style="list-style-type: none"> <li>&gt; Contracts with maritime subject matter; and               <ul style="list-style-type: none"> <li>a. Accidents and injuries which</li> <li>b. occur on navigable waters and</li> </ul> </li> <li>&gt; Involve traditional maritime activity.</li> <li>&gt; Extension of Admiralty Act—extends U.S. maritime law to cover accidents on land caused by vessel on navigable waters.</li> </ul>
Why does it matter?	<ul style="list-style-type: none"> <li>&gt; Maritime law determines vessel status.</li> <li>&gt; Vessel status affects worker status.</li> <li>&gt; Worker status determines employer liability and workers’ rights in the event of accident or injury.</li> </ul>

## RISK MANAGEMENT FOR EMPLOYERS

Offshore operations can involve seamen, maritime employees and other non-maritime employees who may enter the offshore environment. Industry players should consider the need for insurance in the following areas:

- > **“Jones Act” coverage—**  
Most commercial policies do not cover liability to seaman unless specially endorsed so specific Jones Act coverage is necessary.
- > **LHWCA insurance—**  
Any employer who hires non-seaman “maritime employees” must secure payment of LHWCA benefits. They are typically combined with workers compensation coverage.
- > **General liability insurance—**  
Offshore operations involve the risk of death or injury to non-employees. Although this risk is typically covered by commercial general liability or “CGL” coverage, attention should be paid to coverage for offshore operations including liability under general maritime law.

**Appropriate insurance coverage is key.**

## EMPLOYER LIABILITY: WORKER REMEDIES FOR INJURIES

Jones Act Seamen	Everyone else	LHWCA Employee
<ul style="list-style-type: none"> <li>&gt; <b>Maintenance and cure</b>—payment for medical and basic living expenses while injured.</li> <li>&gt; <b>Unseaworthiness</b>—A seaman may recover damages if his injury is due to an unseaworthiness condition of the vessel—even if the condition existed through no fault of the employer; to be seaworthy, a vessel must be properly constructed, maintained, equipped and manned.</li> <li>&gt; <b>Negligence</b>—A seaman may recover damages if employer negligence contributed to the seaman’s injury.</li> </ul>	<ul style="list-style-type: none"> <li>&gt; Usually, covered by applicable state workers’ compensation laws in injured on the job.</li> <li>&gt; If injured while aboard a non-employer vessel, they are owed a basic duty of care and can claim for damages if injured as a result of vessel negligence.</li> <li>&gt; They are not entitled to any warranty of seaworthiness.</li> </ul>	<ul style="list-style-type: none"> <li>&gt; Payment for medical, surgical and other treatment.</li> <li>&gt; Disability benefits, including temporary or permanent, partial or total disability benefits at the rate of 66<sup>2/3</sup> % of average weekly wages.</li> <li>&gt; These are the exclusive remedies for LHWCA employees.</li> </ul>
<p>Seamen have the right to maintenance and cure payments and can sue their employers for negligence or unseaworthiness.</p>	<p>Can potentially claim worker’s compensation and/or damages for vessel negligence.</p>	<p>Disability benefits and medical payment are the <b>exclusive</b> remedies for LHWCA employees.</p>

## EMPLOYER CLASSIFICATIONS

Jones Act Seamen	LHWCA Employees Longshore and Harbor Workers Compensation Act
<ul style="list-style-type: none"> <li>&gt; Test: to qualify as a Jones Act “seaman”, a worker must:               <ol style="list-style-type: none"> <li>contribute to the function of a vessel; and</li> <li>must have a connection to the vessel (or a fleet of vessels) that is substantial in duration and nature.</li> </ol> </li> <li>&gt; Clearly a seaman—captain and crew of an offshore supply vessel.</li> <li>&gt; Clearly not a seaman—engineer who inspects an offshore installation.</li> <li>&gt; Worker assigned to operate equipment aboard a barge or similar offshore work platform—status is less clear and often turns on the facts of the case (i.e. vessel status and nature of connection to the vessel).</li> <li>&gt; Qualification as a vessel is a threshold finding to qualify as a “seaman”.</li> </ul>	<ul style="list-style-type: none"> <li>&gt; Test: to qualify as a LHWCA employee, a worker must:               <ol style="list-style-type: none"> <li>engage in maritime employment—the status requirement; and</li> <li>injured upon the navigable waters of the U.S.—the situs requirement.</li> </ol> </li> <li>&gt; Includes longshoreman, harbor workers, stevedores and other workers at ports and marine terminals, ship builders and ship repairmen.</li> <li>&gt; Excludes office clerical, secretarial, security and data processing employees and other enumerated categories.</li> <li>&gt; Navigable waters includes any facilities adjacent to those waters, such as piers, wharfs, dry terminals, marine railway, or other adjoining area customarily used by an employer in loading, unloading, repairing, dismantling, or building a vessel.</li> </ul>
<p><b>Key factors:</b></p> <ol style="list-style-type: none"> <li>Vessel status</li> <li>Substantial connection to vessel</li> </ol>	<p><b>Key factors:</b></p> <ol style="list-style-type: none"> <li>Maritime employment</li> <li>Injured on navigable waters or adjacent facilities</li> </ol>
OCSLA Worker Outer Continental Shelf Lands Act	Everyone else
<ul style="list-style-type: none"> <li>&gt; Tall workers employed on work sites covered by OCSLA receive the same benefits as LHWCA employees.</li> </ul>	<ul style="list-style-type: none"> <li>&gt; Some workers in the offshore wind industry will not fall into either category of seaman or maritime employee, such as management or engineering personnel who visit offshore environments only occasionally.</li> </ul>



*Block Island Offshore Wind Farm—Courtesy of Deepwater Wind*

# U.S. Offshore Wind Legal Framework

## Equipment Supply/EPC and Long-Term Service Agreements

AUTHOR: **David Hattery**, K&L Gates

### Introduction

Construction of offshore wind projects is fraught with risk. It requires the mobilization of very expensive equipment fitted with high technology into an inhospitable maritime environment. Foundations and cables must be constructed across vast areas of largely unknown seabed subsurface conditions often while coping with high winds and heavy seas. Massive turbine components must be transported and erected, often in short seasonal installation windows of favorable conditions. This requires highly specialized equipment and highly skilled construction professionals. When things go wrong, as things will, solutions are difficult and expensive in terms of both time and project delay. A careful and thorough identification and allocation of these risks and consequences is vital in the project planning and execution phase. The main vehicle for this risk allocation process is the drafting and negotiation of the suite of project agreements among the various parties for design, procurement and construction of the project.

Project documentation for U.S. offshore wind projects will be influenced by both the norms of contracting in the geographic markets where offshore wind has developed (which is mainly Northern Europe) and the contracting structures that have been well-developed in the U.S. onshore wind market. Early projects have offered an interesting mix of forms and processes, which will create some learning opportunities around competing legal, commercial and financing issues.

## European Offshore Contracting Model—FIDIC Forms

Many offshore wind projects in the European market have utilized base forms developed by the International Federation of Consulting Engineers (“FIDIC”). Based in Geneva, Switzerland, FIDIC is an NGO consisting of 104 national associations of consulting engineers. FIDIC based contracts are not often seen in the U.S. construction market, but are widely used outside of the U.S. as the standard starting point for a construction agreement with a fairly-balanced risk allocation between the project owner (called the “Employer”) and the contractor. FIDIC has developed, and offers for sale, many types of contract forms, including the new “rainbow” suite of Yellow, Red and Silver books released in December 2017. The new editions are each approximately 50% longer than previous versions. The most often used version for offshore wind, the Yellow Book, is actually aimed at onshore projects. This requires a good bit of revising to accommodate the realities of very expensive vessel stand-by charges in the event of delay, subsea cabling issues regarding unknown conditions, and cable burial performance criteria, to name just a few critical terms.

FIDIC has its own vocabulary and structure, which is not entirely intuitive on first pass, particularly to those experienced with typical U.S. based EPC contracts. For example, the milestone that is called “Substantial Completion” is roughly similar to the FIDIC term “Taking Over” but with some material differences. Other terms are less subtle, including that the engineer carries the power and authority to make determinations as a neutral party, and that in many cases claims are time-barred and deemed accepted or rejected on the passage of time without objection.

## U.S. Onshore Contracting Model— Bespoke and Vendor Forms

In the U.S., due to the fact that wind turbines are the major cost element and are often procured directly by the developer/owner, the dominant contracting structure for onshore wind projects has been bifurcated contracts. This means that the project owner will contract directly with a turbine vendor for the supply of wind turbines under a Turbine Supply Agreement (TSA) and then separately contract with a contractor for all site and electrical improvements, including the erection of the turbines under an agreement called either an “EPC Contract” or more correctly a “Balance of Plant (BOP) Contract.” While this bifurcated structure was met with initial skepticism by some owners and lenders, with proper coordination in drafting of the risk interfaces, this structure affords solid risk coverage and is now well accepted by the project finance community. TSA forms are typically, but not universally, wind turbine vendor generated forms, while BOP Contracts do not follow any standard form, but they seem to appear in strikingly similar first drafts from project to project. Unlike what is commonly seen in some international power project contract structures, it is not typical to see a coordination agreement used to tie the TSA and the BOP Contract together.

### Turbine Supply Agreements

A typical TSA is heavily driven by the realities of large equipment design, manufacturing, delivery, and performance assurance. Vendors often insist on considerable payment and buyer credit commitment up-front, and well before delivery to the site. Project cancellation charges are often quite steep, reflecting the difficulty a turbine vendor would have in realizing value for specially manufactured turbines in this fast-moving market. Design certification, typically done by an international organization like DNV GL, plays a big role in providing guidance to buyers and lenders and their respective technical advisors on the technical specifications and expected performance. It is not unusual for the buyer and its advisors to conduct factory inspections for a continuing check on the manufacturing quality control and schedule.

Delivery terms and arrangements depend on the point of manufacture and the intended project execution plan. With many major components manufactured overseas to the U.S., there are significant issues regarding transit risk of loss, marine cargo insurance, and shipping logistics and risk management in general. Given the current uncertainty around U.S. customs and tariffs, negotiations will certainly address this point and clearly define which party controls arrangements and bears this risk. Some agreements sweep this issue into the general force majeure provisions, but better practice is to deal with tariffs as component of pricing for the known situation, and a change in law in the event the requirements change from the time of contracting to the time that equipment arrives at the customs port. Delivery of offshore wind components may or may not involve use of shore side laydown areas; vessels may be used that can both deliver and erect major turbine components.

Typical TSA terms include:

- > Delivery delay LDs and Commissioning delay LDs to subcaps of 10% to 15% of the contract price.
- > Overall liability cap of 100% of the contract price, excluding fraud, intentional acts, third party indemnity, and IP claims.
- > Consequential damages waived (except LDs, IP, confidentiality).
- > Mutual indemnity for third party claims.
- > Steep buyer cancellation schedule.
- > Advance payments—as much as 90% paid prior to delivery.
- > Credit support for 100% of buyer’s payment obligations (parent guarantee, letters of credit) and solid credit for turbine vendor.
- > Often paired with service offerings and performance warranty.

### Balance of Plant (“BOP”) Contracts

When paired with a well-drafted TSA, a typical BOP contract for construction and installation of a U.S. onshore wind project is rather more straightforward. It typically, but not always, has a fixed price, contractor provided design, and significant liquidated damages for delay.

Many sophisticated onshore wind project developers manage equipment procurement (and often design services) themselves, which reduces scope and adds owner contract administration duties in pursuit of cost savings. Weather conditions affecting crane operations are dealt with as force majeure above specific operating limits, often with set stand-by crew rates and an assumed "bank" of pre-compensated wind delay days.

Typical BOP Contract terms include:

- > Delay LDs with a subcap of around 20% of the contract amount.
- > May have interim milestone LDs.
- > Contractor takes risk of loss of turbine equipment after delivery and until substantial completion.
- > Overall liability cap of 100% of the contract price, excluding fraud intentional acts, third party indemnity, and IP claims.
- > Consequential damages waived (except LDs, IP, confidentiality).
- > Mutual indemnity for third party claims.
- > Owner has a cover remedy for default termination.
- > Credit support for 100% of contractor's obligations (parent guarantee, letters of credit and maybe performance bond) and for Owner's payment obligations.
- > May have management elements separated—CM—CM at risk, EPCM, etc.

## Particular Issues for U.S. Offshore Construction Contracts

Against this backdrop, we expect to see the first major U.S. offshore projects seek to blend the best practices of FIDIC based European experiences with the standard U.S. onshore practices, which will hopefully incorporate the best of both worlds. Aside from differences in terminology between FIDIC and typical U.S. contracts (which will require some acclimatization), there are a number of specialized offshore issues that will require special consideration:

## Subsea Cable Systems

The design, manufacturing, and installation of cable systems is a highly technical and specialized activity that must be treated with care in project contracting. Because the cable routes can be many miles through widely variable and sensitive coastal, nearshore and offshore seabeds, it is not practical for the cable providers and installers to each expend the resources and time to perform route studies of existing conditions. Rather, such a study is typically done by the project owner/developer, the results of which, combined with other geotechnical and locational information and called "Rely Upon Information," becomes the basis for the cable system provider's contractual expectations. If conditions vary from this expectation in a way that requires a change in methods or that slows production, the cable system provider is entitled to relief in the form of additional time and money. This is preferable to having the cable providers bid much higher prices against the risk of unforeseen and unknown conditions that might not materialize.

Managing cable installation risk can require cooperative efforts during installation. It is not unusual for a representative of the Owner, and often an independent engineer, to be onboard the cable installation vessel observing the efforts being expended and the results being achieved. In certain conditions, it can be more economical and just as effective to ease the burial depth requirement in favor of installing cable protection and this is a call best made in the field at the time of installation. This requires a different contractual structure than the often cumbersome and time-consuming change order process.

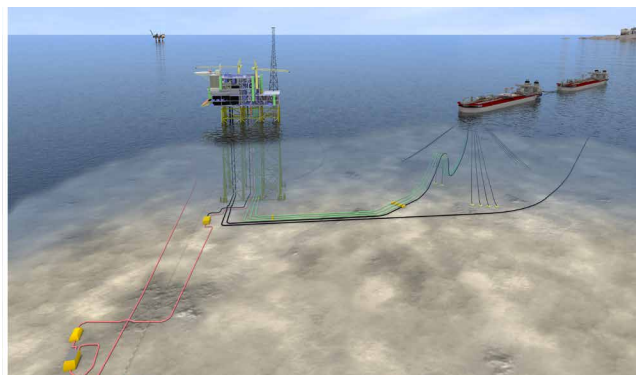

Yttre Stengrund Wind Farm—Courtesy of Vattenfall

## Use of Marine Warranty Surveyor (“MWS”)

Due to the high burn rate for manpower and equipment, the daily costs of project delay and disruption on offshore projects are far higher than for onshore wind projects. As a result, contracting structures need to favor swift notice of problems and expedited problem solving. One way that this can be accomplished is through the use of a marine warranty surveyor. An MWS provides independent technical review during the design and construction process and is often a requirement of construction all-risk insurance. The goal of the MWS process is to review the intended design from a technical and constructability perspective, review processes and systems for compliance with standards and compliance in execution, and to approve the contractor’s operations. In some cases, the contractor cannot proceed with the work without the approval of the MWS and the ongoing operations of the contractor are governed by and must be in compliance with the conditions of such approval.

## Indemnity—Knock for knock vs Comparative Negligence

In the international market, particularly with respect to oil and gas construction projects, it is common to see an indemnity scheme called “knock-for knock.” What this means is that each company is responsible for injuries to its people and loss or damage to its property and equipment, no matter the cause of the injury, damage or loss. Under knock-for-knock, a contractor will not be liable for damage or injury to the owner’s personnel or property, even if caused by the contractor’s negligence, violation of law or breach of contract, and vice versa. As a practical matter, the party responsible for loss or damage is determined not by who is at fault, but by the identity of the Owner of the property. These clauses were developed to provide certainty to the contracting parties, by way of fixing liability at the time of contracting. They also streamline the claims process by avoiding messy disputes over which entity was at fault.

In the U.S., knock-for-knock is not common outside of the oil and gas industry. Further, many U.S. states, at the urging of the construction industry, have enacted statutes that severely restrict the enforceability of indemnity clauses. Typically, these “anti-indemnification”

statutes state that any clause in a construction contract that purports to require a party to indemnify another party for claims and damages caused by the other party’s sole negligence are void and unenforceable. In some states, this applies to comparative negligence claims as well, and a party cannot require the other party to indemnify it to the extent such claim or damage is caused by the first party’s negligence. Of course, knock-for-knock indemnity clauses violate this rule, because responsibility is not based on fault, but simply who was injured or who owns the property damaged. As a result, there is a very real risk that a knock-for-knock indemnity clause in a construction contract could be ruled void and unenforceable.

U.S. federal maritime law offers a potential solution pathway. Maritime law does not have any anti-indemnification statute or analogous concepts and therefore is receptive to knock-for-knock indemnities. As a result, a contract’s indemnity may be enforceable under maritime law but unenforceable under state law and so disputes are often decided on the otherwise technical procedural question of applicable law. This issue is not settled in all jurisdictions where offshore wind project are proposed or may be built.

## Interconnection Issues at FERC

Author: **Will Keyser and Toks Arowojolu,**  
K&L Gates

### Overview of the Function of the RTO/ISOs

In 1996, the Federal Energy Regulatory Commission (“FERC”) issued Order No. 888 creating the function of Independent System Operators (“ISOs”) to coordinate, control, and monitor the operation of the electric power system and facilitate open-access to transmission. Following this, several groups of transmission owners formed ISOs, some from existing power pools. Later, in Order No. 2000, FERC promoted the formation of Regional Transmission Organizations (“RTOs”) to administer the transmission grid on a regional basis throughout North America (including Canada). In each case, the transmission-owning utilities in each region have turned over the operational control of their



respective transmission systems to the independently operated RTO/ISO. However, the transmission owners still own the underlying facilities. The existing RTO/ISO regions are PJM Interconnection LLC ("PJM"), California Independent System Operator ("CAISO"), Electric Reliability Council of Texas ("ERCOT"),<sup>1</sup> Southwest Power Pool, Midcontinent Independent System Operator ("MISO"), New York Independent System Operator, and ISO New England ("ISO-NE").

RTO/ISOs also have the responsibility for planning the expansion and enhancement of the transmission system. The RTO/ISO's Open Access Transmission Tariff ("OATT") governs the planning and operation of the transmission system. Through procedures established in their respective OATTs, the RTO/ISOs identify the necessary upgrades required to accommodate the interconnection of new generation to the transmission system. RTO/ISOs also plan for transmission upgrades necessary to address reliability, economic, and public policy needs.

Each of the RTO/ISOs also operates the complex wholesale markets that provide reliable and economically efficient electric service to customers. The markets vary by RTO/ISO but typically include a "day-ahead market" through which the RTO/ISO matches anticipated electric supply and demand before the operating day, and the "real-time market," which balances the difference between the day-ahead scheduled amounts of electricity and the actual real-time load. RTOs also facilitate a "capacity market," which ensures that sufficient generation capacity is available to accommodate the system needs plus a reliability reserve. The design of the capacity market varies between RTOs.

## Overview of Interconnection Process

In 2003, FERC implemented Order No. 2003 to standardize the process for interconnecting generation to the transmission grid. In Order No. 2003, FERC broadly addressed interconnection issues and adopted pro forma Large Generator Interconnection Procedures ("LGIP") and a Large Generator Interconnection Agreement ("LGIA") to establish the standard terms and conditions by which utilities must provide interconnection service to large generating facilities. FERC defines "Large Generating

Facilities" as facilities with generating capacity greater than 20 MW. As a result of Order No. 2003, each transmission provider, including the RTOs/ISOs, were required to adopt the pro forma LGIP and LGIA and incorporate these documents into their OATT. Similarly, in Order No. 2006, FERC established pro forma interconnection procedures and a standard interconnection agreement for facilities with a generating capacity of 20 MW or less. While each transmission provider was required to adopt the pro forma LGIP and LGIA, FERC also allowed each transmission provider to demonstrate the need for variations from the Final Rule to account for regional differences in the operation of their respective transmission systems if the transmission provider could demonstrate that the proposed variation was consistent with Order No 2003 and 2006.

While each transmission provider may have adopted slight regional variations, the interconnection process generally includes the same procedures governed by FERC's pro forma LGIP. They include:

- > **Application/Interconnection Request:** Customers must submit an application or interconnection request to the applicable transmission provider. Generally, the requesting party must register with the appropriate RTO/ISO before requesting interconnection. The application must include standard information about the project, along with an interconnection study deposit, which will be applied to all costs incurred by the transmission provider to administer the necessary interconnection studies. The applicant will be assigned a queue position based on the timing of the request.
- > **Scoping Meeting:** After the transmission provider notifies the customer that its application is complete, valid, and ready for study, the transmission provider will schedule a scoping meeting with the applicable transmission owners and the customer. The purpose of the scoping meeting is to discuss general preliminary information such as commercial operation dates, alternative interconnection options, transmission data that would reasonably be expected to impact such interconnection options, and to determine the potential feasible points of interconnection. The scoping meeting can be waived by mutual agreement of the parties.

<sup>1</sup> ERCOT is not subject to FERC's jurisdiction.

- > **Feasibility Study:** Next, the transmission provider will conduct a series of studies, beginning with a feasibility study that will identify the transmission upgrades, cost estimates, and construction schedule for the project. Each study is required to be completed in a particular timeframe and is designed to provide increasing levels of accuracy on the estimated costs required to interconnect the generation to the grid. The goal is to provide the customer with increasing levels of information regarding the cost of the facilities from which the customer can evaluate the economics of moving forward in the process. The feasibility study provides a preliminary snapshot of these estimates.
- > **System Impact Study:** The system impact study further assesses the capability of the transmission system to support the requested interconnection. The study provides further refinement of the cost and length of time that would be necessary to implement the interconnection.
- > **Facilities Study:** Finally, the transmission provider will conduct a facilities study, which determines the estimated cost of the equipment, engineering, procurement, and construction work (including overheads) needed to implement the conclusions of the system impact study. It also determines the upgrades or modifications needed at the point of interconnection and provides a more precise level of cost and timing for the interconnection. The applicant may arrange for the design of the required facility upgrades through its own resources or by a third party.
- > **Draft Agreements:** Once the necessary studies are completed, the transmission provider will prepare either an interconnection service agreement and/or construction service agreement that outlines the necessary provisions such as the scope of work, construction schedule, payment schedule, and capacity connection rights. The LGIA includes project specific information such as cost estimates, timeline for interconnection, and operation and maintenance of the interconnected facilities. The LGIA also has security requirements to account for the costs to construct required upgrades, which are often due within a short period after execution of the contract.

After completing construction, the RTO/ISO or utility will test the new facilities to ensure conformance with the relevant terms and conditions set forth in the relevant OATT. The interconnection customer is responsible for the costs of the upgrades necessary to accommodate the interconnection of its generation facility and upon execution of the interconnection agreement or construction service agreement is typically required to provide security for the necessary upgrades. Once the facility is interconnected to the transmission system, many of the transmission providers' OATTs provide for the reimbursement of costs for network upgrades that are deemed to benefit the entire system. Reimbursement typically is provided in the form of transmission credits or financial transmission rights.

## Potential Issues for Interconnecting Offshore Wind Projects

Due to the unique location of offshore wind projects, significant interconnection facilities and transmission system upgrades may be required to interconnect such projects to the transmission system, particularly in areas with limited existing transmission infrastructure. While there may be opportunities for the developer to recoup some of the costs of transmission network upgrades in the form of transmission credits, project-specific interconnection facilities will be borne solely by the developer. Developers will need to take into account the costs necessary to interconnect a project and the timeframe for construction of such upgrades when determining the viability of a project.

The interconnection process is a first-in-time process. Thus, the timing and cost of interconnection also may be affected by changes to the scope of a project or in the event that earlier-queued projects drop out of the interconnection queue. Models used in the study process to develop cost estimates for a particular project are based on the assumption that all earlier-queued projects will be placed into service and pay for their respective system upgrades. Because transmission is "lumpy," later queued projects will likely benefit from these upgrades. However, to the extent that earlier projects drop out of the interconnection process, a developer may be required

to fund more upgrades than first expected. Any change to the scope of the project, including increasing the capacity of the project or changing the project's point of interconnection may reset that project's position in the interconnection queue. Moving to the back of the interconnection queue also could lead to delays or additional costs.

Developers should also take into account the time required to complete the interconnection study process. As outlined above, the interconnection process involves a number of comprehensive studies that must be completed prior to executing an interconnection agreement. The level of costs and studies required for the interconnection service are impacted by the type of services provided. Many transmission providers offer different levels of interconnection service for those customers that seek to provide capacity service versus those customers who want to provide energy-only service. Transmission providers also offer different

levels of interconnection for resources that seek to use network transmission service and those that do not. These higher levels of interconnection often require more in-depth analysis of the interconnection request that results in more upgrades and higher costs.

Recently, FERC reformed the interconnection process in Order No. 845. In doing so, FERC sought to identify inefficiencies and to provide a more streamlined, transparent interconnection process. Transmission providers were required to submit revisions to their pro forma LGIPs and LGIAs to comply with the order by August 7, 2018. The reforms are designed to enhance the timeliness, clarity, and consistency of information provided to interconnection customers during the interconnection process.



—Courtesy of Atkins

# Offshore Wind Power Purchase Agreements

AUTHOR: **William Holmes**, K&L Gates

## The PPA

A power purchase agreement (PPA) is a long-term contract between the developer of an offshore wind project and a buyer, sometimes called an “offtaker”. The PPA will usually have a term of 15, 20, or 25 years and gives the project a predictable revenue stream that will support project financing.

## Utility Power Purchasers

The power purchaser is often a public utility that is buying the output of a wind project to serve its customers. In the United States, public utilities come in a number of forms, including investor owned utilities (“IOUs”), municipal utilities, cooperatives, and public utility districts. If the utility is also buying the project’s output to meet a state renewable portfolio standard (“RPS”), it will require that all renewable energy credits (“RECS”) associated with project’s output be “bundled” and sold along with the energy. If the utility is interested

only in buying an energy supply at a favorable price, it may allow the seller to “unbundle” the RECs from the energy and retain them for sale to a third party under a separate REC agreement. The buyer may also bargain for capacity rights and ancillary services produced by the project, although Seller sometimes wishes to retain these services and market them separately.

## CI&I Power Purchasers

Over the last several years, a new class of non-utility power purchasers have emerged for wind projects. These buyers are sometimes referred to as commercial, industrial and institutional (“CI&I”) customers and include corporations, universities, hospitals and other non-utility buyers that want to purchase wind energy to meet zero-emission, renewable portfolio or other corporate sustainability goals. Historically, such buyers have been unable to purchase renewable energy, because the utility that supplies their power has an exclusive service territory that legally entitles it to be the sole supplier of the customer’s energy. More recently, however, some U.S. states have adopted “direct access” programs that, subject to various limitations, allow CI&I customers to purchase their energy supply from a supplier other than their incumbent utility. Other states have created



—Courtesy of Atkins

"green tariff" programs that enable customers to purchase renewable energy from a seller by buying renewable energy from an incumbent utility, which in turn buys the renewable energy from a project developer. However, most CI&I customers procure renewable energy through a "virtual power purchase agreement" (VPPA), which is described in more detail below.

## Conditions Precedent

The PPA will usually bind both parties as soon as it is signed, but the obligation to perform the PPA for the full term is often qualified by conditions precedent. For example, a utility buyer's obligations are often conditioned on the utility's receipt of an order from its public utility commission that allows it to recover its power purchase costs in the rates that it charges to its customers. For its part, the seller may bargain for conditions precedent that allow it to terminate the PPA without liability if, for example, it has not obtained by a specified date a final, non-appealable permit, or an interconnection agreement, or a material element of site control. That said, the market in 2018 is a buyer's market that focuses on projects that are likely to be completed successfully and timely in order to vest federal production tax credits. As a result, Seller conditions precedent are currently less common and, if present, tend to be few in number.

The buyer will be interested in keeping track of project development. Accordingly, the PPA may require the seller to submit monthly or quarterly reports documenting its progress toward commercial operation. The PPA will probably set out "milestone dates" by which certain key events must occur, such as the signing of the project's interconnection agreement; receipt of all permits in final, non-appealable form; financing commitments; notice to proceed deadline; and the target commercial operation date. Buyers will often press for more milestone dates to provide greater insight into the project's progress, while Sellers (particularly those with an excellent record of completing projects) prefer fewer.

The consequences of a failure to achieve a milestone vary across PPAs. Some agreements treat a missed milestone as a default, but this outcome is disfavored by sellers. The PPA will sometimes require the seller to post additional security or pay liquidated damages if it misses a milestone, with the understanding that any liquidated damages paid will be returned to seller if the project ultimately achieves commercial operation on time. Seller may also be required to deliver and implement a cure plan, explaining in detail how the seller will address the delay or other consequences caused by a missed milestone. The PPA will usually extend milestone dates to the extent that a delay is caused for force majeure, transmission provider delay, or buyer default.

## Commercial Operation

The PPA will require seller to achieve commercial operation by a specified "target commercial operation date." If it fails to do so, seller is required to pay the buyer liquidated damages, often stated on a dollar per MW basis, for each day that commercial operation is delayed. If commercial operation is not achieved by a "guaranteed commercial operation date," which usually occurs 180 to 365 days after the target commercial operation date, the buyer will have the right to terminate the PPA.

A PPA will usually provide a mechanism for extending the target commercial operation date and the guaranteed commercial operation date for delays caused by force majeure, buyer default, or the transmission provider's failure to complete interconnection facilities or network upgrades by a specified date. However, the PPA may specify an "outside date" or a "long stop date" beyond which the agreement may not be extended.

The energy generated by the project after it has been interconnected to the grid but before it has achieved commercial operation is usually referred to as "test energy." If the PPA does not require the buyer to purchase test energy, the seller will sell the test energy for the available market price. If the PPA requires buyer to purchase test energy, the price will usually be discounted relative to the contract rate that comes into effect on the commercial operation date. The contract rate may be fixed for the term of the PPA, or it may escalate over the term.

The seller is motivated to achieve commercial operation as soon as possible in order to avoid paying delay damages, to prevent the buyer from terminating the PPA, and to convert the test energy rate into the full contract rate. The PPA will define "commercial operation" by reference to a list of criteria. In general, the project must have obtained all of its permits and must be interconnected to the grid and capable of delivering energy reliably. The commercial operation clause may call for independent engineer certification of specified matters, as well as officer's certificates concerning the status of the project. From the seller's perspective, the criteria for commercial operation should be objective and not left to the discretion of the buyer. The PPA should also provide that an independent engineer will resolve any disagreements between the parties about whether commercial operation has been achieved.

Some PPAs allow the seller to declare commercial operation for the whole wind project if at least 90% to 95% of the project's installed capacity has been interconnected and is capable of reliably delivering energy. The seller will be required to complete the project after declaring commercial operation, and it will be liable for liquidated damages on a per MW basis to the extent that it fails to build the project to its full expected nameplate capacity.

## Caps on Pre-COD Damages

The buyer wants to incent seller to build the offshore wind project, and it will want to be able to recover damages from seller if (i) the project does not achieve commercial operation by a specified date, and (ii) the failure is not excused by force majeure or by the buyer's default. For financing and commercial reasons, the seller will want to cap its liability to buyer if it is unable to build the project or the project does not achieve commercial operation by a specified date. The PPA's delay liquidated damages clause, the development security clause, and the default clause are usually tied together in a way that makes it clear that seller's liability for a pre-COD default cannot exceed the development security that seller is required to post.

The buyer will be concerned that if seller's liability is capped, seller may have an incentive to "arbitrage" the PPA in order to re-market the project to take advantage of rising power prices. The buyer's concern is usually addressed by including a right of first offer clause, which states that if the PPA is terminated because the project does not achieve commercial operation, whether for seller default or force majeure, the buyer will have the right, for one to three years after the termination occurs, to purchase the output of the project on the terms and conditions agreed upon in the PPA.



—Courtesy of Atkins

This “right of first offer” or “ROFO” provision assures buyer that seller will not take advantage of a pre-COD liability cap to remarket the project.

## Credit Support

Credit support in U.S. wind PPAs typically takes the form of an irrevocable letter of credit, a guaranty from a credit-worthy entity, or cash deposited into escrow. In the United States, utility buyers rarely post credit to support a power purchase agreement. PPAs will occasionally provide that if a utility buyer experiences a defined downgrade event, it will have an obligation to post credit support. The credit rating of the utility buyer is thus a very important consideration for the seller and the parties providing financing for the wind project.

CI&I PPAs, in contrast, typically require corporate buyers to post credit support. Even in cases where buyer credit support is not required upon execution of the PPA, the agreement will usually require the buyer to post credit support if it experiences a downgrade event. In a CI&I PPA, adequate buyer credit support is very important to project financing.

The developer of a U.S. wind project will be a special purpose entity, typically a limited liability company. Since the seller’s credit will not be sufficient to support its obligations to the buyer, Seller will be required to post credit support. The posting may occur in tranches, with one-half being posted upon execution of the PPA or within a certain number of days thereafter, and the other half being posted when buyer has received approval of the PPA from its public utility commission. Seller’s pre-COD credit support typically ranges from around \$50 to \$125 per kW of expected nameplate capacity, depending on the state or region.

In some PPAs, utility buyers ask for a second lien on the project’s assets, either in lieu of or in addition to other forms of credit support. Although developers occasionally view a second lien on assets as a low-cost alternative to posting more liquid credit support, second liens are unusual in U.S. wind PPAs. At a minimum, the second lien will result in higher transaction costs and will

involve the buyer in the negotiation of an intercreditor agreement with the project’s lenders. If at all possible, sellers should just say “no” to a utility buyer’s request for a second lien.

PPAs usually distinguish between pre-COD security and post-COD security. Oddly enough, given that the project has been significantly de-risked once it has achieved commercial operation, buyers often insist on *higher* security after COD. Post-COD security levels are typically tied to twelve to 18 months of expected project revenue and may in some cases be subject to adjustment over the term of the PPA depending upon energy market conditions. Recent PPAs seems to reflect a growing recognition that it may be appropriate for the post-COD security to be lower than pre-COD security.

PPAs will sometimes, though not often, include a post-COD cap on seller’s damages up default and termination of the PPA. Such caps usually distinguish between technical defaults that cause the buyer to terminate (e.g., failure of a guarantor to maintain a required credit rating, or failure to achieve availability or output guarantees), which are subject to the cap, and willful defaults (e.g., a breach involving a sale of project output to a third party), which are never capped. In rare cases, buyer may ask for a cap on its liability, but such PPAs are challenging to finance, and seller should avoid agreeing to a buyer liability cap.

## Deliveries of Energy and RECs

The PPA will specify the point at which seller will deliver the energy from the project. In a “busbar” sale, the energy will be delivered to the buyer at the project’s point of interconnection with the grid. Other PPAs require the seller to deliver energy a specified point on a transmission system, in which case the seller will be responsible for securing the transmission required to deliver the energy to that point. In organized markets operated by Independent System Operators (ISOs) or Regional Transmission Organizations (RTOs), seller may be required to deliver to a market hub. Seller will in any case bear the costs of building all of the project’s interconnection facilities.

The PPA will likely require RECs from the project to be delivered to buyer through one of the nine independent renewable energy tracking system, such as the Western Renewable Generation Information System (“WREGIS”), Midwest Renewable Energy Tracking System (M-RETS), or New England Power Pool Generation Information System (NEPOOL GIS). These systems are intended to account for the generation and retirement of RECs and to avoid double counting. CI&I offtakers will typically require that RECs be certified by Green-e. Green-e RECs may be sourced from projects that are tracked by one of the tracking systems or that, with less frequency, are delivered to buyers by attestations.

## Curtailments

The seller usually has the right to curtail the project's output in the case of an emergency, and the seller must curtail the project if so instructed by the transmission provider or another authority having the right to regulate the facility's output. If the curtailment results from a transmission system emergency, transmission system maintenance or similar circumstances, the seller is usually not compensated for the curtailed energy (although curtailed energy should always be counted toward the fulfillment of any output guarantee). If the curtailment is instructed by the buyer, either directly or through buyer's bidding strategies in an organized

market, the seller is usually compensated for the curtailed energy at the contract rate plus a gross up for lost production tax credits (“PTCs”), calculated on an after-tax basis. Buyers will sometimes bargain for uncompensated curtailment, and the circumstances that trigger a compensated vs. an uncompensated curtailment are often heavily negotiated.

## Performance Guarantees

Wind PPAs with utility buyers will usually include an output guarantee under which the seller will be required to pay liquidated damages to the buyer if seller fails to achieve a minimum level of output during a specified period. The liquidated damages are based on the shortfall of actual project output relative to the output guarantee, with the price per MWh for liquidated damages often being set by reference to the weighted average of a market price index over the period in question. Output guarantees will sometimes allow the seller to make up the shortfall by delivering make up energy and RECs during the year following the shortfall event.

Output guarantees are often structured to exclude the first year of operation and to be measured over a one-year period or rolling two-year period. The PPA should be drafted so that seller receives credit for energy that could have been generated but was curtailed by the



—Courtesy of Atkins



buyer or the transmission provider, or that could have been generated but for a force majeure. Seller may also be credited for energy that could have been generated but was not because of a serial defect in the project's equipment (though crediting for serial defects is usually allowed only during the first one to three years of project operation).

Wind PPAs sometimes include a mechanical availability guarantee, either in lieu of or in addition to an output guarantee. Seller promises that the project's mechanical availability will meet a certain minimum (usually 95% to 97.5%). If it fails to do so, the shortfall in mechanical availability will be converted into a MWh shortfall, which will result in a payment of liquidated damages calculated in a manner similar to that used for an output guarantee. For accounting reasons, CI&I PPAs often include only a mechanical availability guarantee and no output guarantee. Sellers are generally happy to offer only a mechanical availability guarantee, since such a guarantee does not expose seller to the risk that the winds at the project are lower than expected.

## Force Majeure

A force majeure event will excuse the affected party's duty to perform under the PPA. In the seller's case, a force majeure may function to extend deadlines or to excuse seller's obligation to generate and deliver energy, particularly in connection with a performance guarantee. A well-drafted force majeure clause will describe events that are definitely considered to be force majeure events, as well as those that are definitely not considered force majeure events. For offshore wind projects, sellers will want to make it clear that a force majeure event includes not just a storm, but also the time during which the facility must be evacuated and shut down in anticipation of the storm, as well as the time required to return it to operation.

## CI&I Transactions

Offsite CI&I wind PPAs are structured as either "physical" or "virtual" transactions. A CI&I buyer may choose a physical wind PPA when (1) the buyer has a discrete load, such as a data center, that it wants to serve with renewable energy, and (2) it can use retail

direct access to deliver the energy to the load. In this case, the buyer or a designated market participant will take title to the energy that the project generates. The energy would then be transmitted to a delivery point on the system of buyer's local utility and delivered to buyer's load by the utility. Physical PPAs are physical, forward contracts that are usually not subject to Dodd-Frank Act reporting requirements.

Although a number of CI&I continue to enter into physical PPAs, virtual PPAs (VPPAs), which are also known as synthetic PPAs, are being deployed more frequently. A CI&I buyer may use a VPPA when (1) it has a distributed load, such as scattered retail outlets; (2) open access is not available to the retail load(s), which means that the load(s) can receive energy only from an incumbent utility; or (3) when projects that could be contracted with a physical PPA are not cost-effective sources of renewable energy compared to those reachable by a VPPA. Even with a virtual PPA, however, some buyers may require that the project be located in the same market as the load so that the virtual energy is generated and used in the same region.

A VPPA is a "contract for differences," the terms of which may be embedded in the VPPA, set out in a separate long-form swap agreement, or documented as a transaction under an ISDA Master Agreement. The VPPA is a swap transaction that is subject to Dodd-Frank reporting requirements. In such a hedge arrangement, the buyer will purchase the project's output at a "fixed price" and keep all of the associated RECs. The remaining "brown power" will be sold into the market and a "floating price" will be paid by the seller or an energy manager. The floating price will be subtracted from the fixed price to produce a settlement amount, which is reconciled monthly--if the floating price exceeds the fixed price, seller will pay buyer; if market prices are less than the fixed price, buyer will pay seller. The buyer continues to take and pay for energy from its local utility. At the end of the day, the buyer ends up with a long-term contract that will supply it with RECs from an additional renewable energy project which, ideally, will be located in the same area as the load to be served.

A VPPA depends on the availability of a floating price, so it is typically used only to purchase output from a project located in an organized market, such as an ISO or an RTO. Because such markets sometimes send negative price signals, the buyer does not want to be obligated to settle when the floating price is negative—for example, the VPPA might allow the owner of a wind project to deliver energy into a negative price to capture the production tax credit, but the buyer would not be obligated to bear the cost of the negative price. Similarly, buyer will want the floating price to be determined at a market hub rather than at a local marginal price (LMP) node so that the floating price is not set in a more limited, less liquid market that is subject to congestion risk. Sellers will, of course, be concerned about the basis risk between the LMP node and the hub.

Accounting issues also play a prominent role in corporate procurement transactions. For example, attorneys familiar with renewable energy PPAs may assume that a buyer will want an output guarantee to incent the seller's performance. However, in the corporate procurement context, an output guarantee will represent a "notional value" that will trigger derivative accounting, an outcome that corporate buyers prefer to avoid. The commonly used alternative is a mechanical availability guarantee that calculates liquidated damages on a percentage of shortfall basis rather than on a per MWh basis, since the latter could be deemed to assign a notional value that requires derivative accounting.

## Renewable Energy Tax Credits

**AUTHORS: Charles Purcell and Elizabeth Crouse,**  
K&L Gates

### FEDERAL TAX INCENTIVES

#### Tax Credits for Renewable Wind Energy Property, General

For many years, federal tax incentives have played an important role in developing preferred conventional and renewable energy resources. Code Section 45 provides for production tax credits (PTCs) when electricity produced by certain renewable energy

facilities (usually wind) is sold to a third party during the ten years after the facility was "placed in service." The PTC rate is adjusted annually. The maximum PTC rate for electricity sold in 2018 is 2.4 cents per kilowatt hour of electricity sold.

The PTC is being phased out for wind facilities. The PTC amount is reduced by 20% for facilities for which construction begins in calendar year 2017; reduced by 40% for wind facilities for which construction begins in calendar year 2018; and reduced by 60% for wind facilities for which construction begins in calendar year 2019.

Offshore wind developers may instead opt to claim the Investment Tax Credit under Code Section 48 (ITC) in lieu of the PTC. Rather than accruing on a per kwh sold basis, the ITC is taken as a percentage against qualifying portions of the cost of the facility, historically 30% of qualifying costs could be claimed as a tax credit. Given the likely high cost per installed kilowatt of capacity for offshore wind, it is likely that the ITC will be more valuable than the PTC, though an actual economic analysis should be performed for each project.

The ITC phase-out schedule for offshore wind follows a similar pattern to that of the PTC. The ITC started at a credit equal to 30% of qualifying investment, and is being phased down in parallel steps with the PTC. As a result for facilities on which construction is deemed to start in 2017 the ITC will be 24%, in 2018 the credit will be 18%, and in 2019 the credit will be 12%.

Qualifying a project as having started construction during 2018 or 2019 requires meeting one of two tests, both of which will require careful planning and consideration: 1) starting physical construction of a significant nature, which given the permitting and planning process may prove difficult for most project owners; or 2) incurring at least 5% of the total qualifying completed project costs during 2018 or 2019, which may represent a significant investment very early in the development cycle as offshore wind projects typically represent very large capital commitments and additionally the relative size of the safe-harbor commitment versus the actual potential credit will be very high in 2019.

There have been a series of bills introduced to either extend the existing tax credits for offshore wind or create a new tax credit support regime. These have generally followed the same structure as the existing PTC and ITC (credits based on production or investment). None of these legislative efforts have yet gained adequate momentum in Congress to receive serious consideration and likely will not without a considerable push from the industry. Support for offshore wind has a naturally limited constituency (20 states have no coastline and another 10 have very limited or only Great Lakes coastline) and moving any substantive legislation in the current environment is quite challenging.

## Depreciation Deductions

For federal income tax purposes, the basis of tangible property is recovered over a specified useful life using one of several methods. The favored method is the modified accelerated cost recovery system or MACRS, which generally provides for accelerated depreciation deductions in the earlier years of a property's useful life. Wind energy property that is located and used within the United States (as further described below) could potentially be depreciated using the MACRS method over 5 years, if such property would qualify for the investment tax credit by reference to the requirements applicable to solar energy property. Very generally, these requirements are that the property uses wind energy to generate electricity; is property for which construction is completed by the taxpayer (or original use of which begins with the taxpayer); is property eligible for depreciation; and which has met certain eligibility standards. Absent these conditions, wind energy property is otherwise depreciated using a depreciation period that depends on its class life, which can be 20+ years, depending on the life span of the property.

In addition, renewable energy property with a recovery period of 20 years or less that is placed in service after September 27, 2017 and before 2023 generally will qualify for 100% immediate expensing, sometimes referred to as "bonus" depreciation. Bonus depreciation will continue to be available through 2026 at reduced rates of 80% for property placed in service in calendar year 2023; 60% for property placed in service in calendar

year 2024; 40% for property placed in service in calendar year 2025; and 20% for property placed in service in calendar year 2026.

## Additional Notes for Offshore Wind Facilities

In order to qualify for the PTC, production must take place in the United States. The geographical definition of "United States" for purposes of the PTC includes the states, the District of Columbia, U.S. possessions, and submarine areas that are adjacent to the territorial waters of the United States or its possessions and over which the United States or its possessions have exclusive rights under international law.

In addition, qualification for the favorable MACRS 5-year depreciation regime depends on property not being used "predominantly outside of the United States." It is not always clear if offshore wind energy property is used "predominantly outside the United States." The definition of "United States" for purposes of the MACRS method includes the states and the District of Columbia. In addition, states that border the Atlantic or Pacific Oceans generally have jurisdiction over submerged lands out to three nautical miles offshore.

Outside of these boundaries, additional analysis is recommended to confirm that the site for wind energy property is properly within the United States for purposes of claiming the PTC and the favorable depreciation under the MACRS method. Production facilities used predominantly outside the United States will not qualify for the PTC and will be required to use the depreciation period that corresponds to the wind energy property's regular depreciation period, which, as discussed above, can be 20+ years depending on the class life of the property.



*Beatrice Offshore Wind Farm—Courtesy of Smulders*

# Project Phasing

## Project Planning

AUTHOR: **Úna Brosnan**, Atkins

Project development timelines vary from region to region and depend on a number of factors (consent timeline, weather, availability of vessels etc.). Below are some typical project timelines for key development phases.

### Development Period

The development period from the timeframe of identification of a project site has typically taken 4-5 years in Europe and includes elements such as securing project approvals, site investigations, tender process, finance and major contract awards.

Having clear energy policy and consenting regime and establishing funding mechanisms to give developers and investors a clear roadmap of the development timeline are all imperative to support the industry.

Consenting regimes and approval timelines vary from country to country but having a clear timeline is key for planning of other aspects of the project and to provide confidence to investors.

From a developer's perspective once the lease is awarded, the developer needs to perform the following activities in the development period:

- > **Data collection:** There are several data collection activities that need to be performed in this period. Data needs vary from geotechnical data, to the wind resource and marine data that are required for various permit filings.
- > **Permit Applications:** State and federal permit applications need to be identified and the permit applications will be filed during this time period. The schedule for the permits is discussed in the permitting section separately.

## Manufacturing

The project design is typically finalized during the permit approval process and includes optimizing the engineering of the windfarm through FEED ("Front End Engineering Design") and Detailed Design processes. Major contracts are tendered and are readied for placement in parallel with the permitting cycle. Once the permits are issued then the larger contracts such as manufacturing can be released so elements such as foundation and substation manufacturing can start.

In offshore wind farm developments one of the key cost reduction areas has been attributed to driving standardized designs and serial fabrication methods. Engagement of fabrication and installation contractors from early stages to ensure structures can be manufactured, transported and installed with ease is important. This not only provides fabrication and installation efficiencies and best practices to be identified from an early stages of design but also allows for manufacturing variations to be considered should multiple fabricators awarded. An example where early engagement was key in Europe was on the Beatrice project where there were three fabrication yards for the 84 jacket foundations. All three fabrication yards had slightly different fabrication methods which had to be considered.

Depending on the project size the overall manufacturing can take up to three years for the project. The project risk level (which may be due to pressure on lead in schedule or subsidy deadlines) can also dictate if the manufacturing is started after the permits are finalized or during the last phases of the permitting period.

## Offshore Installation

Installation of the project components in the field can take up to three years depending on the size of development, construction season, program and vessel capability and availability. This phase includes elements such as site preparation, installation of foundations, turbines, transformer stations and final testing and commissioning. This phase can in some delivery programs overlap the manufacturing schedule by up to a year. In addition to the structure installation, the inter array cables, export cable and onshore substation construction can also take place at the same time.

In the U.S., projects have an additional offshore installation consideration with respect to the Jones Act as referenced earlier. At present in the U.S., there are no Jones Act compliant heavy lift installation vessels suitable to install some of the larger/deeper offshore structures and turbines which are being planned for U.S. projects so alternative Jones Act complaint installation sequencing is currently being considered. Ideas such as feeder vessel systems to support any international installation vessels are being explored as options.

## Operations and Maintenance (O&M) and Life Extension

Projects are typically designed for an operational life of up to 25 years without major life extension upgrades however ensuring that a robust O&M strategy is in place for the lifetime of the project is essential to allow owners and operators to react where required and minimize project downtime.



*Innovation Installation Vessel—Courtesy of Deme*

Ongoing O&M of an offshore wind farm is typically managed from a local base close to the wind farm which helps to assist with reaction times. O&M involves regular turbine and structure maintenance based on the preventive maintenance (PM) schedule or condition-based maintenance (CBM) approach as identified by the asset owner. These approaches drive the levels of inspections and maintenance required. Most windfarms will have target availability of 97% or above so O&M strategy is a key factor.

Monitoring regimes and instrumentation are also a key consideration not only to assist the O&M phase but also to assist in later phases such as life extension and decommissioning as it can give an opportunity to have actual live data for the condition of the structures which can subsequently allow accurate analysis.

## Decommissioning

Typically, at the end of the project life, unless life extension is an option, the project decommissioning will need to take place in accordance with the permit conditions for the project.



*Yttre Stengrund Wind Farm—Courtesy of Vattenfall*



Rampion Offshore Wind Farm — Courtesy of Atkins

## Phases of BOEM's approvals for offshore wind projects.



### Planning and Analysis

~2 YEARS

- > Intergovernmental task force
- > Request for information or call for information and nominations
- > Area identification
- > Environmental reviews



### Leasing

~1-2 YEARS

- > Publish leasing notices
- > Conduct auctions or negotiate lease terms
- > Issue lease(s)



### Site Assessment

UP TO 5 YEARS

- > Site characterization
- > Site assessment plan

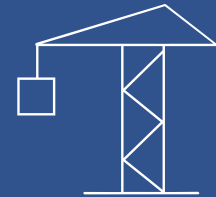

### Construction and Operations

~2 YEARS (+25)

- > Construction and operations plan
- > Facility design report and fabrication and installation report
- > Decommissioning
- > Environmental and technical reviews

[https://www.boem.gov/Regulatory-Roadmap/ Phases of BOEM Approvals for offshore wind projects](https://www.boem.gov/Regulatory-Roadmap/Phases%20of%20BOEM%20Approvals%20for%20offshore%20wind%20projects)



# Consent and Permitting

AUTHOR: **Michael Golden**, Atkins

## Project Permitting

Project permitting is a critical part of the project lifecycle and is one of the key development risks to the project. The Energy Policy Act of 2005 ("EPAAct") authorizes BOEM to issue leases, easements, and rights of way to allow for energy development on the Outer Continental Shelf ("OCS"). EPAAct addressed previous uncertainties regarding offshore wind projects and provided general guidance and a framework for BOEM to follow when authorizing projects. In 2009, the Renewable Energy Program Regulations (30 CFR 585) were enacted to provide a detailed governance structure and agency obligations for BOEM to follow while overseeing the offshore renewable energy industry. BOEM's renewable energy regulations were updated in 2011 and will be updated in the future as necessary to support the evolving industry.

BOEM's renewable energy program occurs in four distinct phases for authorizing offshore wind energy projects: planning and analysis, leasing, site assessment, and construction and operations (as per text on preceding page).

## Planning and Analysis

The Planning and Analysis phase consists of environmental due diligence, compliance review, and consultation with stakeholders, tribes, and State/Federal agencies to identify suitable areas for offshore wind energy leasing. This phase begins with BOEM either issuing a Request for Interest ("RFI") in the Federal Register to determine competitive interest in a potential offshore wind lease, or by issuing a Call for Information and Nominations ("Call") for a wind energy area. The publication of a Call will initiate a comment period for BOEM to obtain industry input on interest in the wind

energy area including nominations of indications of interest in specific lease blocks within the area. BOEM also seeks comment from any interested party related to particular geological, environmental, biological, archaeological, and socioeconomic conditions, use conflicts or other information that could affect potential leasing and development of particular areas. Once the Call is complete and comments have been analyzed, BOEM may proceed with specific lease area identification and further environmental analysis. Environmental analysis is conducted by BOEM according to the National Environmental Policy Act ("NEPA") and consists of a draft Environmental Assessment ("EA"), 30-day public comment period, Final EA, and Finding of No Significant Impact ("FONSI"). The Planning and Analysis phase may take up to two years for completion.

## Leasing

The Leasing phase results in BOEM issuing a commercial wind energy lease to a developer. Leases may be issued either through a competitive or noncompetitive process. The EPAAct requires that BOEM issue leases on a competitive basis, unless it determines that there is no competitive interest in the proposed lease area. When only one developer has indicated interest following an RFI, BOEM may issue a lease non-competitively. The environmental analysis and preparation of an EA/FONSI are still required for non-competitive leases as described in the Planning and Analysis phase.









The competitive lease process begins with BOEM publishing a Proposed Sale Notice ("PSN") for a lease area including the terms and conditions developed through the EA and stakeholder consultation process. The PSN has a 60-day comment period during which the interested applicants submit their qualifications to BOEM including evidence that they are eligible to hold a lease and demonstrating their technical and financial

capability to conduct the authorized lease area activities. BOEM then publishes a Final Sale Notice (“FSN”) and identifies qualified bidders who must then submit the bid deposit as specified in the FSN. An auction is held to identify the winning bidder who is then eligible to pay the balance of their bid and execute the lease with BOEM. The lease does not grant the lessee the right to construct any facilities, but instead grants the right to prepare plans for lease development which must be approved by BOEM in subsequent phases. The Leasing Phase may take between one and two years for completion.

## Site Assessment

The Site Assessment phase includes submission and approval of a Site Assessment Plan (“SAP”) as well as conducting site assessment activities on the lease area. The purpose of the SAP is to provide a description of the assessment activities to be performed including details related to the construction of a meteorological tower or buoys on the site. This would include the results and supporting data from survey investigations conducted in support of the design and siting of the meteorological

### IMPACTS MATRIX FOR CONSTRUCTION AND OPERATION PHASE OF OSW FARM

	Direct Impacts	Indirect Impacts
 Geology and Hazards	> Disturbance to sea floor; Scour	> Instability of turbine structure > Reduced Water Quality
 Water Quality	> Turbidity; Accidental releases	> Reduced Water Quality
 Threatened and Endangered Species	> Displacement; Disruption to breeding, feeding	> Injury > Permanent displacement > Mortality
 Sensitive Bio Resources/Habitats	> Habitat Disturbance/loss	
 Avian Resources	> Bird strikes; Habitat loss	
 Coastal and Marine uses	> Spatial/temporal conflicts with other authorized users	> Interference with shipping, military, aircraft
 Socioeconomics	> Reduced fishing, recreation and tourism activities; Increase in non-local employees	> Decreased jobs/revenue > Increased jobs/revenue (construction) > Reduced housing/services available
 Archaeological Resources	> Effects on historic resources: Visual impacts	> Destruction/damage to historic resources or viewsheds
 Air Quality/Climate Change	> Climate change/Carbon emissions	> Construction emissions > Zero carbon emissions (operation)

instrumentation. The investigation should include geotechnical, shallow hazards, archaeological resources, geological survey, and biological survey. Specific SAP requirements are outlined in BOEM's Guidelines for Information Requirements for a Renewable Energy Site Assessment Plan (February 2016). The SAP must be submitted within 12 months of lease issuance at which point BOEM performs a review for document completeness. BOEM then approves, disapproves, or approves with modifications the SAP. The Site Assessment phase may be completed in one year but could take as many as five years for completion.

## Construction and Operations Plan

The Construction and Operations phase includes submission and approval of a Construction and Operations Plan ("COP") which provides a description of all proposed activities and planned facilities (onshore and offshore) proposed for the lease area. The COP should provide details concerning construction, commercial operations, maintenance, decommissioning, and site clearance procedures. The COP must include data and results from survey investigations (including those conducted to support the SAP) and will provide the analysis of environmental and socioeconomic effects resulting from the offshore wind project. Figure 2 below identifies (at a cursory level) the potential direct and

indirect impacts associated with an offshore wind farm which may require analysis in the COP. Specific COP requirements are outlined in BOEM's Guidelines for Information Requirements for a Renewable Energy Construction and Operations Plan (February 2016). The COP must be submitted six months prior to the completion of the site assessment term outlined in the SAP, or the lessee may choose to submit the SAP and COP concurrently. There are trade-offs associated with submitting the documents separately versus concurrently related to risk, uncertainty, milestone objectives, cost etc. that should be factored into the decision. Once received, BOEM performs a review for document completeness and prepares a NEPA Environmental Impact Statement ("EIS") prior to approving, disapproving, or approving with modifications the COP. The lessee must then submit a Facility Design Report, Fabrication and Installation Report, and decommissioning financial assurance to BOEM who may then approve the commercial operations to proceed within the lease area. The Construction and Operations phase may take up to two years to obtain BOEM approval.

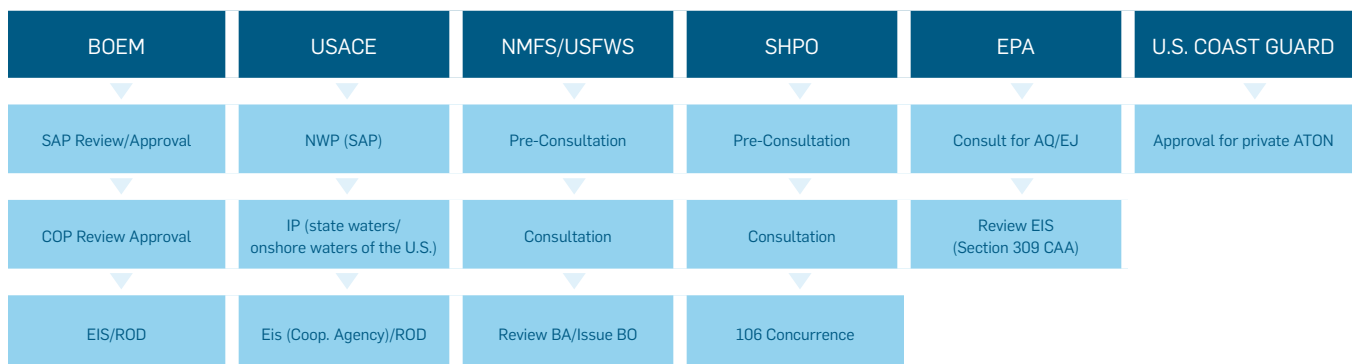

Figure 2 Potential federal permits/clearances

## Other Pre-Construction Permits and Coordination

In addition to the BOEM SAP and COP, there is a complex permitting process that will run concurrently with or tangentially to the BOEM process. These federal activities include: U.S. Army Corps of Engineers (“USACE”) permits for impacts to waters of the U.S. (Nationwide Permit (“NWP”) for SAP and Individual Permit (“IP”) for COP) pursuant to the Clean Water Act; consultation with the United States Fish and Wildlife Service (“USFWS”) for the preparation of Biological Assessment for impacts to federally protected species; consultation with the USFWS pursuant to the Migratory Bird Treaty Act; consultation with the National Marine Fisheries Service (“NMFS”) for Incidental Take Authorization pursuant to the Marine Mammal Protection Act; consultation with NMFS for Essential Fish Habitat pursuant to the Magnuson-Stevens Act; coordination with U.S. Coast Guard (“USCG”) for Approval for Private Aids to Navigation; Section 106 Concurrence with State Historic Preservation Office (“SHPO”) for cultural resources; and Environmental Protection Agency (“EPA”) permit for the Outer

Continental Shelf Air Regulations. In addition to permits, there is also coordination with other relevant stakeholders, including Department of Defense (“DoD”). At the state level, approvals/permits include a Section 401 Water Quality Certificate, Coastal Zone Management Act consistency determination, and other construction-related permits. Approvals for impacts to state protected species and forest/trees may also be required.

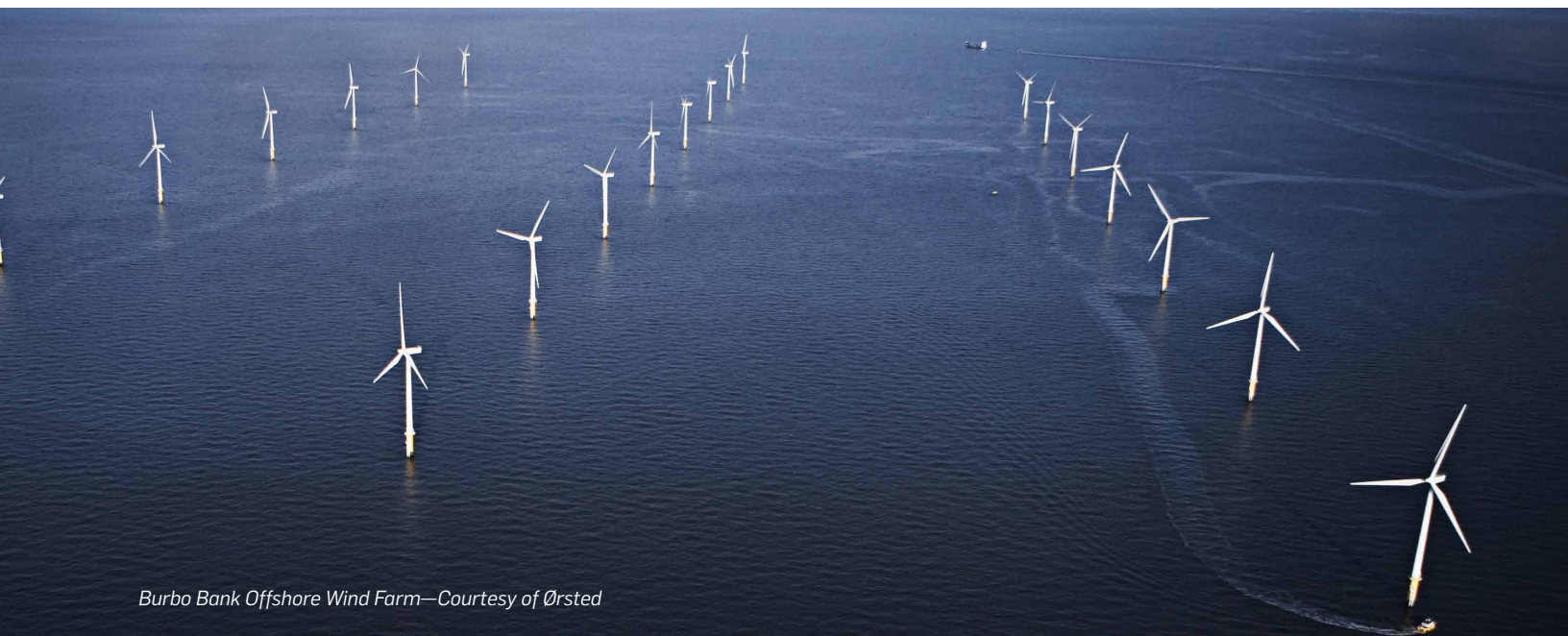

## Post-Construction Mitigation and Monitoring

Post-construction monitoring and agency coordination would be required to fulfill mitigation commitments outlined in the COP, BOEM EIS, and agency permits/approvals that aim to avoid and minimize impacts to natural and socioeconomic resources. The following table provides a summary of the potential mitigation that may be implemented to address potential impacts during operation. It should be noted that monitoring is developed for project and site-specific considerations and the items in the table are not inclusive of all possible mitigation scenarios.



*Burbo Bank Offshore Wind Farm—Courtesy of Ørsted*

## POTENTIAL MITIGATION TO ADDRESS OPERATION IMPACTS

Resource	Mitigation/Monitoring
 Water Quality	<ul style="list-style-type: none"> <li>&gt; Implementation of a Spill Prevention, Control, and Countermeasure Plan</li> </ul>
 Physical Oceanography, Geology, and Sediments	<ul style="list-style-type: none"> <li>&gt; Periodic underwater inspection of turbine foundations, inter-array cables, and export cable to assess aggregation, scour and/or sub-seafloor exposure</li> </ul>
 Benthic Macroinvertebrates	<ul style="list-style-type: none"> <li>&gt; Post-construction surveys for comparison of seasonal and spatial patterns of species abundance compared to pre-construction conditions</li> </ul>
 Fish	<ul style="list-style-type: none"> <li>&gt; Post-construction surveys to assess local fish community populations compared to pre-construction conditions</li> </ul>
 Marine Mammals and Sea Turtles	<ul style="list-style-type: none"> <li>&gt; Protected species observers on vessels utilized during construction and operation to provide visual species monitoring</li> <li>&gt; Post-construction underwater monitoring and analysis of operational noise</li> <li>&gt; Adherence to vessel speed restrictions to prevent vessel strikes of marine mammals</li> </ul>
 Avian Species	<ul style="list-style-type: none"> <li>&gt; Post-construction monitoring (vessel-based, nocturnal, and/or radar-based) during operation to determine bird and avian collision mortality</li> </ul>
 Threatened and Endangered Species, Essential Fish Habitat	<ul style="list-style-type: none"> <li>&gt; Post-construction species-specific monitoring if required during by USFWS and NFMS during consultation</li> </ul>
 Cultural Resources	<ul style="list-style-type: none"> <li>&gt; Implementation of an Unanticipated Discovery Plan during construction and operation to outline procedures to follow in the event that submerged cultural resources are encountered</li> </ul>
 Wetlands and Other Waters of the U.S.	<ul style="list-style-type: none"> <li>&gt; Implement USACE permit conditions</li> <li>&gt; Purchase wetland mitigation credits or implement on-site wetland mitigation as required by the USACE</li> </ul>
 Commercial and Recreational Fishing, Boating, and Diving	<ul style="list-style-type: none"> <li>&gt; Post-construction coordination with stakeholders as needed</li> </ul>

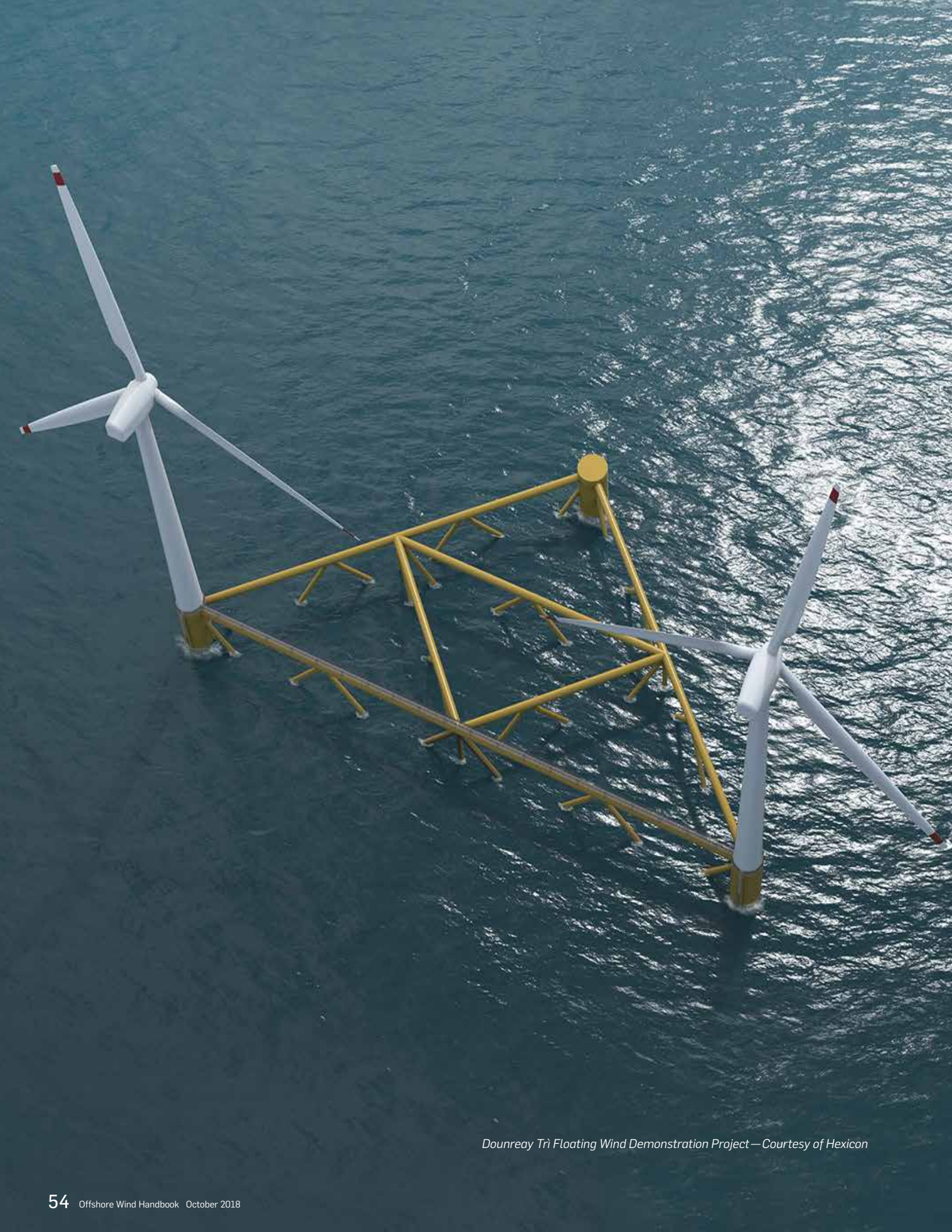

*Dounreay Tri Floating Wind Demonstration Project—Courtesy of Hexicon*

# Offshore Wind Infrastructure

AUTHORS: **Úna Brosnan and Andrew Thompson**, Atkins

## Offshore Wind Turbine (“WTG”)

Offshore Wind Turbine Generators (“WTG”) are considerably larger than their onshore relatives. The early turbines were converted from their onshore siblings and suffered from being exposed to the brutal saline conditions found offshore. Turbine OEMs recognized the issue and moved to designing turbines specifically for the offshore market through enhancing the designs to not only address the more aggressive environment but also to reduce operations and maintenance due to the higher costs associated with transporting maintenance crews and replacement components to and from offshore windfarms.

The largest installed turbines today (Autumn 2018) is rated to 8.4 MW (Aberdeen Offshore Wind Farm, UK) however this will soon be overcome with projects such as Triton Knoll which is currently being designed with a 9.5MW turbine and the recent industry announcement and launch of a 12MW machine.

The pace and scale of turbine technology development has been unprecedented with offshore turbines growing from 2MW to the recently announced 12MW and could continue to grow further in the coming years. This growth and technology innovation is one of the key contributing factors to the industry cost reduction drive. The main advantage being that less turbines would need to be installed offshore due to the higher rating of these larger turbines. Less turbines need fewer foundations, less cable and fewer sites to travel to for installation and maintenance. In addition to the actual scale of offshore turbines, improved reliability has also greatly helped to streamline maintenance and improve turbine availability.

There are a number of offshore turbine providers in the market that have products that have been developed off the back of years of experience and through extensive R&D programs. The competitive nature of the sector is greatly helping to drive innovation as developers continuously look for solutions to help reduce their Levelized Cost of Energy (“LCOE”) figures.

Figure 1 The Scale-Evolution of Turbines

8.0MW Turbine — Height to tip 200m

Siemens 3.6MW — Height to tip 150m

Humber Bridge — 155m

London Eye — 135m

Big Ben Tower — 96.3m

Withernsea Lighthouse — 98m

Average House — 7m



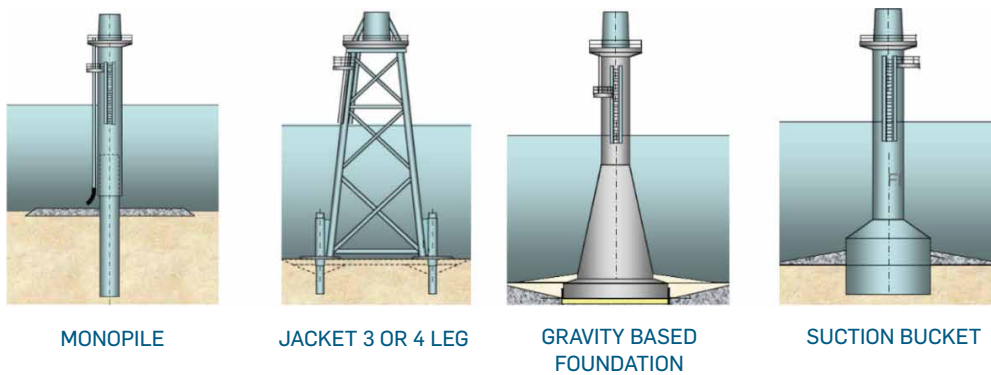

**Figure 2**  
*Typical fixed bottom WTG  
 Foundation Substructures*

## WTG Foundations and Substructures

### Fixed Bottom Solutions

Early developments were relatively near to shore and located in shallow water, this combination best suited fixed bottom solutions such as monopiles. As the turbines got bigger, further offshore and developments moved into more transitional waters (typically 30m to 60 m water depths) then jackets have been more widely deployed given they are a familiar and trusted concept from the hydrocarbon sector. Alternative substructures have also been successfully deployed, although in smaller numbers which include gravity base, tripod, suction bucket (rather than traditional pin piles) and hybrid solutions.

To date the market has been dominated by monopiles with jackets starting to become more common place as developments get deeper and turbines get bigger. That said we are starting to better understand monopiles and have more advanced technology that can support the

fabrication, transportation and installation of larger diameter structures. This could result in monopiles moving into traditional jacket space supporting large turbines in 40m water depths in the near future.

The industry has been highly successful in driving down cost within the foundations and substructures from a CAPEX and OPEX perspective. Application of the following have made considerable contribution to the industry cost reduction:

Adoption of larger turbines:

- > Larger project size i.e. generating volume hence economies of scale
- > Standardization
- > Serial fabrication
- > Optimization of design and fabrication processes.
- > Pushing the boundaries industry design codes
- > Improved understanding of ground conditions (e.g. Pisa study)



*Beatrice Jacket— Courtesy of SHL*



*Blyth Demonstrator— Courtesy of EFD*



## Floating Wind

A floating wind turbine is an offshore wind turbine mounted on a floating structure that allows the turbine to generate electricity in water depths where fixed-foundation turbines are not feasible.

There are number of benefits to floating offshore wind in the table below.

Floating substructures are typically categorized as follows:

- > Barge
- > Semi-submersible
- > Spar
- > Tension Leg Platform

The market is also seeing the introduction multi turbine and hybrid solutions into the market.

Floating wind has been behind the curve in comparison with fixed foundations simply as near shore developments started first. There are over 4000 fixed structures whereas floating structures can be measured in double digits so it is difficult to make cost comparisons based on actual data.

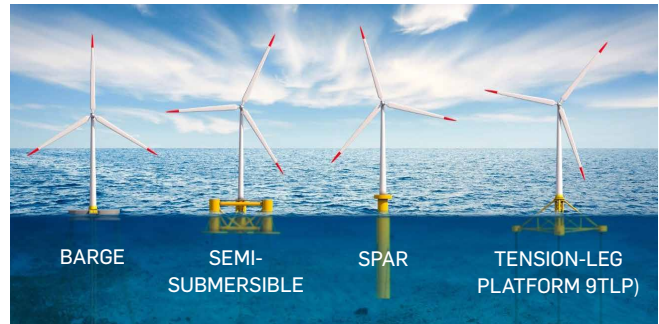

**Figure 3** Typical WTG Floating Substructure Concepts

Floating Offshore Wind is on the pathway to becoming commercially competitive as the technology strives to catch up. There have been several demonstrators and pilot project installed globally and the next step for the industry is to realize commercial scale projects where they then will be in a position to demonstrate its ability to drive down cost similar to that in fixed bottom solutions (i.e. serial fabrication, scale etc.). The World's first commercial floating offshore wind farm (Hywind) was installed in Scotland in 2017 with six 6MW turbines on a spar substructure. By 2030, Equinor have announced they are targeting the cost of floating offshore wind to be \$50-\$74 per MWh.

Floating Offshore Wind creates new opportunities within the sector through the associated supply chain, employment and export opportunities from which first

## BENEFITS OF FLOATING WIND

Challenge	Benefit
Increased wind exploitation	> Higher, more consistent wind and larger turbines
Shore side assembly	> Eliminates heavy lifts, reduces risk, less weather dependency
Larger resource base	> Not restricted to shallower water depths (typically >50m)
Significantly reduced ground risk	> When compared against fixed structures
Conduct major repairs/upgrades	> Ability to tow structures to shore
Deployment further offshore	> Less planning risk and visual impact
Anchored moorings	> Pre-installed gravity anchors and mooring lines, can eliminate piling activities and associated negative environmental impacts
Safety	> WTG installation alongside, less activities offshore, no need for jack-ups

movers and those with experience in related fields such as offshore oil and gas or maritime will benefit most.

For the U.S., the opportunity for Floating Offshore Wind predominately lies on the west coast of the U.S. where waters are a lot deeper than the East coast (typically 500 – 1000m).

## Offshore Electrical Systems and Subsea Cables

### Overview

The cost and efficiency of an offshore wind farm is influenced by a number key element's when identifying an optimum electrical network for an offshore wind farm:

- > The type of electrical system (AC or DC)
- > Transmission length/distance from shore
- > Transmission voltage
- > Inter turbine collector system (say 33kV or 66kV)
- > Rated power
- > Farm topology
- > WTG being proposed
- > Wind farm wind speed

With these many variables to consider, comprehensive computational optimization is necessary to determine an optimal solution for the windfarm. This analysis should take into consideration whole life cycle cost and be influenced by aspects such as loss/downtime and reliability.

### Offshore Substation

Finding the balance between resilience and cost of an offshore substation is one of the key optimization challenges for offshore wind farm developers today. The design decision drivers for an offshore wind farm can be different from those of utility systems and each client can have different drivers for substation development from both a technical and commercial perspective which can also vary from one country to another. Designers therefore need to establish from an early stage a definite method which will allow them to assess options against the requirement of an individual windfarm and provide results which then will be taken forward to underpin economic decisions around a development. Below is an example of the variance between some of the European approaches in the UK, Germany (DE) and The Netherlands (NL).

An Offshore Substation facilitates the systems to collect and export the power generated by an offshore wind farm through specialized submarine cables and are an essential component of offshore wind farms, especially at large, multi-megawatt sites. They are critical to stabilizing and optimizing the voltage generated offshore, reduce potential electrical losses and transmit the electricity to shore in an economical manner to maximize the return on investment for the project. One of the key challenges during a design is identifying the life-cycle cost implication of transmission losses and availability losses (i.e. during downtime).

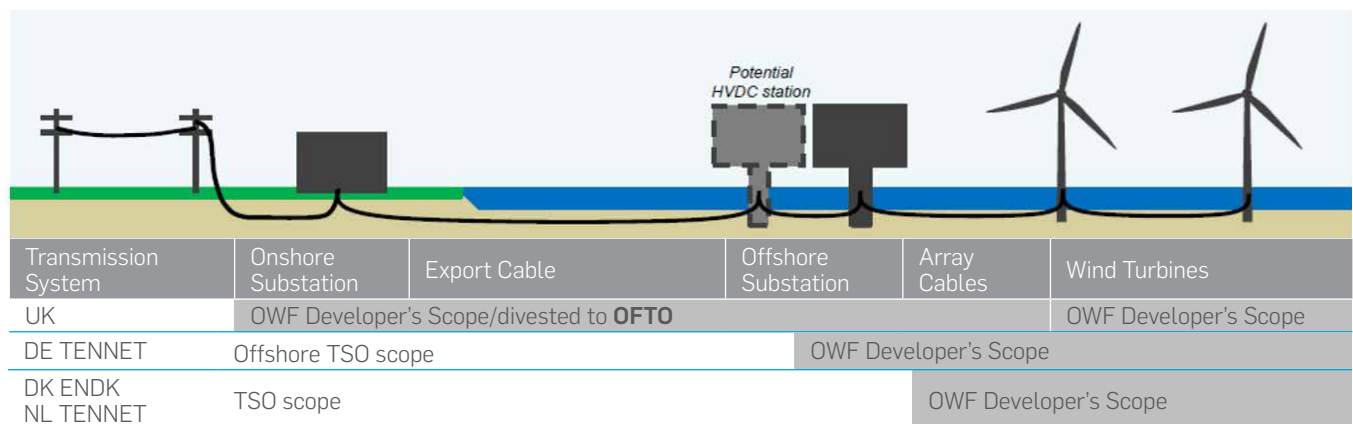

Figure 4 Offshore Transmission Owner (3rd party)—Courtesy of Atkins

The governing purpose of an Offshore Substation is to reduce electrical losses on the system by increasing the voltage and then exporting the power to shore. Early developments, small or pre-commercial (less than 100MW) nearshore projects (less than ~15km) or project with grid connection at collector voltage (i.e. under 36kV) don't require an offshore substation however as capacity increases, we move to deeper waters and further offshore the requirement increases which often results in the need for one or multiply Offshore Substations (OSS). Part of the decision-making process also has to include discipline specific questions such as High Voltage AC or High Voltage DC and reactive compensation System studies are the starting point here to assess the concept and connection options in the transmission and distribution network.

Offshore substations typically serve to step-up the voltage from the site distribution voltage (30 to 36 kV) to a higher voltage (100 to 220 kV), which typically will be the connection voltage. This step-up dramatically reduces the number of export circuits (subsea cables) between the offshore substation and the shore. Typically, each export circuit may be rated in the range 150 to 200 MW. On designing an offshore electrical network, the following elements need to be taken into consideration during the early development of the transmission network for a wind farm:

- > Capacity of windfarm
- > Distance from shore
- > HVAC /HVDC
- > Reactive compensation requirements
- > No. of export cables to shore
- > No. of transformers on the OSS (i.e. capacity dependent)
- > Redundancy
- > Equipment failure rates
- > Traditional OSS or Offshore Transformer Module (OTM)
- > Power supply for ancillary/LV systems
- > 33kV v 66kV inter array cables
- > OSS maintenance strategy

- > Interlinking of multiple offshore OSS's/adjacent Offshore Wind farms
- > Availability target/requirements
- > Installation strategy

As the offshore wind sector has matured then project capacities have increased and developments have moved further offshore. To date, the majority of offshore wind projects have been built with AC transmission (with the exception of small number of collector hubs in Germany) however the industry has been successful to date in delaying the requirement for expensive DC transmission through the introduction of mid-point compensation platforms. Such a system requires an AC/DC converter station both offshore and onshore; however both stations are large installations.

In the next wave of UK projects expected to enter the 2019 Contract for Difference (CFD) auctions, the industry could see HVDC technology take its first steps on projects such as Dogger Bank and Norfolk.

### Traditional Offshore Substation vs a Module Approach

Transmission infrastructure for an offshore wind farm typically accounts for 10-20% of the capital cost of the project. A large proportion of this cost can be directly related to the development, manufacturing and installation of offshore substation platforms (OSS) which are needed to convert the array voltage (33kV or 66kV) to a higher level (155kV or 220kV) to allow for efficient transmission. Should offshore converter platforms be required for HVDC transmission then projects costs will be higher therefore driving cost reduction through reduction in platform size and weight offers a massive potential. If the total weight of topsides and substructures can be kept below 1,000t each, it allows for the smaller and less costly installation vessels to be utilized during installation which can have a significant impact over cost. The introduction of a single deck, modular concept approach has made inroads on project such as the Beatrice offshore wind farm where two Offshore Transformer Modules ("OTM") were installed in 2018, the first of its kind in the offshore wind sector.

## Integrated Offshore Substations

Another approach being explored in industry is integrating two HVAC substation along with one HVDC converter platform on a single support substructure. The aim of this approach is toward weight reduction of the structure when compared to utilizing current HVDC technology. This approach has yet to be applied to a live project however studies to date are presenting a significant opportunity for reduction in CAPEX and OPEX due to the leaner cost and service requirements associated with having one platform instead of multiple individual platforms. This approach however is dependent on regional transmission development approaches (i.e. in German HVDC platform would be built by the transmission operator and development would build the AC platform).

## “Interlink” of Offshore Platforms

With the capacity of offshore wind projects increasing developers are assessing their risk and availability profiles to understand how best they can mitigate against downtime. A number of developers are planning to install transmission cables (interlinks) linking multiple local windfarm offshore substations. If failure of the export cable occurs then the project affected still has capacity to export some (or all) of its power to shore through the interlink (depending on the capacity available on the cable and interlink). This interlink essentially provides a security mechanism on projects in the event of a cable failure and provides a more cost-effective alternative to utilizing multiple cables connecting to a single common

substation from each of the adjacent offshore projects. The costs for the interlink cable would be shared between project owners based on a formula reflecting availability and capacity. In some markets Regulatory approaches would need to change such as currently in the UK the transmission charging methodology for offshore transmission considers only radial cables to shore and therefore does not take account of any interlinks that may be built.

## Cost Reduction

The industry is evolving. Electrical innovations helping to bring down costs include:

- > Increasing the Inter Array Cable Voltage to 66KV
- > A 66kV systems increases the power density through the cables resulting in more cost-effective cable system. Adopting a 66kV system does have an increased unit cost associated with higher voltage cables, terminations and switchgear however these costs are outweighed with benefits such as the following:
  - Array cable length reduction (circa 20%-30%, depending on site layout) which has a reduction in CAPEX for radial and ring inter array design
  - Reduction in the number of offshore substations required for a higher voltage system
  - Additional design options can be considered, including the option to connect all the power to a single platform and introduces the possibility of using cheaper aluminum cables.



Galloper Offshore Transformer Platform (UK)—Courtesy of Atkins



Siemens Offshore Transformer Module (OTM)—Courtesy of Siemens.com



- > Adoption of the midpoint reactive compensation platforms
  - The introduction of mid -point reactive compensation platforms has been a key driver in pushing out the requirement/adoption of HVDC technology in the UK today. HVDC technology not only brings significant cost but also reduces risk. On projects such as Hornsea 1, the developer, Ørsted, had three collector platforms and reactive compensation platform located between the shore and the windfarm. This approach facilitates electrical reactors, which limit the electrical losses, over the course of the HVAC Transmission through the provision of reactive compensation.
- > Adoption of Larger Turbines
  - The introduction of larger turbines has increased overall substation design power resulting from the larger voltages experienced on the system. This in turn impacts on higher cable requirements and thus results in increased costs in the electrical system. These higher costs however are balanced by increased electrical output of the bigger turbines.
- > Standardization of offshore substation structures
  - One of the biggest and most cost prohibitive issues associated with Offshore Substations is that they are typically designed and fabricated in a bespoke fashion, with each substation a custom fit for a specific development. This has resulted in a higher cost per substation thus standardization will improve efficiencies and drive innovation which will help with cost reduction.
- > Adoption of GIS over AIS
  - The adoption of GIS (Gas Insulated Switchgear) as an alternative to AIS (Air Insulated Switchgear) has led to significant cost reductions when assessed over the lifetime of the asset. The classic reason to use GIS over AIS is when there is a limited installation footprint available. GIS systems may be marginally more expensive in terms of initial cost ("CAPEX"), however when considering the total cost (i.e. including OPEX too) of a substation over its lifespan, GIS can work out significantly cheaper due to not only this reduced footprint requirement offshore but also through lower maintenance requirements and through improved system reliability.

## Future Market Disruptors

Below are a number of industry concepts or early ideas which could have potential to change the dynamic of offshore wind if introduced in the years ahead;

- > **Floating Substations** – could greatly assist in areas with environment challenges (e.g. Typhoon's, seismic or simply areas sensitive to piling solutions). Concepts could also have cost advantages around installation and may assist in areas such as the U.S. where there are installation restrictions around the Jones Act.
- > **Low Frequency AC** – a concept currently in the early stages of development which could result in the ability to transmit power at a frequency lower than the standard grid frequency enabling an increased transmission distance capability through the subsea cables. This has the potential to remove the requirement for HVDC transmission systems.
- > **An offshore Hub Development** – Tennet (Offshore grid operator in Germany and The Netherlands) are currently exploring a concept by where an offshore artificial island is developed instead of a platform which then can be utilized as a central hub for installation and operation and maintenance activities.
- > **Utilizing existing offshore infrastructure** – i.e. whether it be existing offshore interconnector runs or connecting into an offshore load (e.g. an offshore Oil & Gas platform).
- > **Exploring if Offshore Wind turbines could export HVDC direct from the individual turbines**
- > **Submerged Substations** – we have seen Microsoft deploy a data center off the coast of Scotland in 2018 and a similar type approach could be applied to offshore substations however there are challenges around O&M operations and the cable connection.



Block Island U.S. Project — Courtesy of DWW: BWIF

# Development— Challenges and Project Risk

AUTHOR: **Úna Brosnan**, Atkins

The risk of developing offshore wind projects in each country is inherently different. Variances predominately lie in elements such as grid connection and transmission arrangements, consenting/permitting requirements and processes, transparency to the types of studies the developer needs to undertake along with the in-country subsidy or financial support mechanisms.

By way of example to fundamental differences, in the UK and France developers need to develop and construct the transmission elements of the asset (i.e. offshore substation, export cable and onshore substation) however in countries such as The Netherlands, Germany and Denmark the transmission assets are provided by the state.

On the consenting side, developers in the UK are responsible for undertaking all site assessments

The Cost of Electricity Generated from

**NEW OFFSHORE  
WIND PROJECTS  
HAS FALLEN BY 50%**



(including the geotechnical and metocean studies) however in Denmark and The Netherlands the government takes ownership of running most of the site assessment activities in including metocean measurement campaign.

Below is a high-level summary of some of the key risks/challenges which need to be taken during the development of a U.S. offshore wind opportunity:

## OFFSHORE WIND KEY RISKS AND CHALLENGES FOR THE U.S. MARKET

Risks	Details
Policy and Regulation Risk	> The industry is still in its infancy in the U.S. and policy for the development of Offshore Wind is predominately being driven at State level. Policy has now been developed and passed in a number of states (such as MA and NJ). It is imperative that the industry have a clear and consistent policy, drive, and clear visibility of its pipeline by each of the states so the developing supply chain can have the confidence to invest.
Regulatory Risk	> Multiple permits are required for a development in the U.S. (In contrast to 1 permit in the UK). Further to this there can be significant difficulty in obtaining permits.
Financing and Cost Competitiveness	> The most pressing challenge the industry faces is the cost of offshore wind, and the related lack of available power purchase agreements and/or state and federal policies to support those high costs. NREL estimated that in 2013, the cost of offshore wind energy was \$215/MWh however recent data suggest that costs have stabilized, and expect prices to decrease through 2020 driven by recognition of market maturity in Europe and recent winning bids for competitive subsidies in the UK driven down to £57.50 and "zero bid" or "zero subsidy" bids in Germany and The Netherlands.

## OFFSHORE WIND KEY RISKS AND CHALLENGES FOR THE U.S. MARKET (continued)

Risks	Details
The Jones Act	<p>&gt; In the U.S. Offshore Wind market there are restrictions around use of Installation vessels in U.S. waters. The Jones Act is an important piece of legislation which will have a profound effect on the OSW industry.</p> <p><b>What does the Jones Act entail?</b></p> <p>&gt; Section 27 of the Merchant Marine Act of 1920, the Jones Act, prohibits the transfer (pertains to transportation and points in the U.S.) of merchandise between domestic locations unless the vessels are American as certified by the Secretary of Transportation.</p> <p>This means that, for a vessel to be compliant with the Jones Act, it <i>must be</i>:</p> <ul style="list-style-type: none"> <li>- Constructed in the U.S.</li> <li>- Owned and operated by a qualified U.S. citizen and was fabricated in the U.S.</li> <li>- Have a U.S. citizen management – specifically Chairman of the Board, Chief Executive Officer, and no more than a minority of the number necessary to constitute quorum of the Board can be non-citizens.</li> <li>- 75% owned by U.S. citizens.</li> <li>- Overall vessel control must be in the hands of U.S. citizens.</li> <li>- The Secretary of Transportation may approve the use of non-certified vessels upon finding that no U.S. vessel is suitable and reasonably available for the transportation of offshore wind equipment. Once a wind farm foundation is in place in U.S. federal waters, the structure may be considered a port and thus require servicing by U.S. vessels.</li> </ul> <p><small>Note: excludes cable installation vessels</small></p>
Supply Chain	<p>&gt; There is limited design, fabrication and installation infrastructure and experience in the North East of working in an offshore environment. To date most of the offshore marine experience lies in the gulf due to the presence of the offshore hydrocarbon sector.</p>
Vessel Availability	<p>&gt; Installation vessels are specialist so need careful planning to ensure they are suitable and available.</p>
Political	<p>&gt; Changes in the political environment can have an impact on the project. Political and policy stability is crucial in securing developer and investor confidence.</p>
Grid	<p>&gt; Transmission interconnection and upgrade requirements can significantly impact projects. If grid connection dates cannot be met, there is a risk of delay to operational start of the offshore wind farm.</p>



## OFFSHORE WIND KEY RISKS AND CHALLENGES FOR THE U.S. MARKET (continued)

Risks	Details
Ramp up of Serial Fabrication in Fabrication Facilities	<p>&gt; This is a risk based on the limited resources available to deliver the project works. To date in the U.S., fabrication of substructures has been predominantly for one-off hydrocarbon assets. Fabrication processes and yards need investment to prepare for serial production.</p> <p><small>Note: To date, a number of European fabricators have seen some substantial losses on projects due to issues around serial fabrication.</small></p>
Local Content Requirements	<p>&gt; The local content requirements can have an impact on the project and may vary considerably from state to state. In some states, they may require/mandate substantial subcontracting of supply chain which can have a cost impact but also brings a wider integration risk to projects.</p>
Weather Risk	<p>&gt; Good Quality environmental data is essential to put robust offshore working strategies in place, i.e. installation and Operations &amp; Maintenance. Weather downtime of vessels can place a considerable cost/risk on a project as clients are generally liable for these costs. This can be considerable if using some of the larger vessels which can have day rates in the order of \$ 185k–375k per day.</p>
Contracting	<p>&gt; A robust contracting setup can balance strong risk and interface management. At present, the U.S. has an inexperienced local offshore marine experience and lacks a background in offshore wind hence, a significant risk to be posed for contracting and the ability of the supply chain to take some ownership of the project risk.</p>
Financial Risk	<p>&gt; Having adequate access to funding and being prepared for any key criteria to meet investor requirements around investment/lending.</p>
Visual Impact	<p>&gt; Risk of objection to the offshore wind farm due to visual impact. The U.S. the Cape Cod Offshore wind farm experienced considerable objection from local residents due to visual impact. At present, wind farm location are being sited where possible a minimum 10 miles from shore to minimize visual impact; however, this should not be underestimated.</p>
Technical Risk	<p>&gt; There is considerable confidence in substructures such as monopiles and Jackets to date, due to their use in European projects however technical risk should not be underestimated as Turbines get larger and technology develops to meet new development and challenges the limits of codes and operational limits. E.g., HVDC technology involves bringing in larger substructures which bring not only a technical risk around the sheer size of the substructures in comparison to a HVAC substructure, but also in the electrical components.</p>
Environmental Risk	<p>&gt; Understanding how the development could have impact on the local environment, such as fishermen, migrating birds, fish and mammals is important as this will drive the technical solution.</p>



# Construction and Offshore Installation

AUTHORS: **Úna Brosnan and Andrew Thompson**, Atkins

## The Marine Environment

Due to the onerous nature of the offshore environment, construction and pre-commissioning activities are typically performed onshore to minimize offshore works and risks where possible. An added benefit to maximizing onshore works is that they are typically less expensive than their offshore equivalent. Therefore, it is important that different construction and installation strategies are considered and developed at an early stage.

A workability assessment considers the offshore environment, marine spread hydrodynamic behavior, and the operational procedures so as to evaluate environmental risks of the operation. Experience indicates that bad weather conditions are the main cause for delays in transport, handling and installation of offshore windfarms. It should be noted that to increase time "on site", the offshore wind industry generally requires 24/7 operations as it is impacted severely if bad weather is prolonged.

It is important to specify the weather windows to perform the installation (and O&M) operations as well as to ensure high safety levels during transportation and operation. Suitable weather with sufficient duration for each task is required when deriving the installation strategy. For instance, weather windows will be defined in order to avoid excessive pitch/roll motions which may damage the cable cargo/load and other equipment during transport. Parameters such as window duration, wave height, wind speed and current speed are all a factor.

Based on this available weather window data, overall installation schedules can be developed and estimated weather downtimes (WDT) related to the installation vessel operability criteria can be calculated.

## Manufacturing

The manufacturing process has been a key factor in contributing to the cost reduction of offshore wind through a strong emphasis not only on quality but also on driving standardization, serial fabrication and optimization of the manufacturing process itself. Due to the size and complexity of turbine blades, each blade must be crafted to the highest quality standards in order to ensure reliability. This fabrication process can be very costly and labor intensive. Turbine blades must be able to maintain their strength and aerodynamic structure during virtually non-stop operations over its typical 20-year design life.

As the demand for offshore wind components increases, coupled to the fact we are seeing an unprecedented drive in wind turbines technology and "scale-up" to even larger sizes, manufacturers are being continuously challenged to optimize their processes further to lower the cost of wind energy. Some of the challenges manufacturers experience are due to the sheer scale of structures (e.g. bigger "roll" diameters for monopiles), load out frequency, and lift capacity.

Manufacturing structures for the offshore wind industry differs greatly from the hydrocarbon sector. The offshore wind sector demands multiple (and at high volume) substructures to be produced and in many cases have the requirement for constant loadout to meet a continuous offshore installation schedule. Driving standardization across substructure design coupled with streamlining serial fabrication processes has been pivotal for the supply chain to meet its delivery and cost challenge. The power of early collaboration in the supply chain across design, manufacturing and installation phases should not be underestimated and should be encouraged as early as possible.

# Offshore Installation

## Vessels:

### Installation Vessels

Offshore windfarm installation presents challenges not only from a technical but also from a cost and risk perspective. Due to the sheer scale of offshore structures such as the WTG and the OSS, there is a requirement to contract some of the world's largest installation vessels that have the lift capacity and hook height for wind turbines, needless to say this list of vessels can be limited. For offshore installation the typical installation vessels utilized fall into the following categories:



**Heavy Lift Vessel (HLV)** — A HVL is a heavy lift crane vessel which utilizes dynamic positioning rather than an anchoring system to hold its position during installation.



**Jack Up vessel** — A Jack Up rig or a self-elevating unit is a mobile platform that consists of a buoyant hull fitted with a number of movable legs, capable of raising its hull over the surface of the sea. The buoyant hull enables transportation of the unit and all attached machinery to a desired location. Once the vessel is in place, it jacks its legs up to the required elevation above the sea surface supported by the sea bed.

The main difference between the HVL, and Jack up is that mobilization of equipment for the jack-up can take place at either the vessel's home port or the load-out port. For an HVL, the mobilization will usually take place at the vessel's home port as it is unlikely the HVL will be required to access the load-out port as it will spend all its time in the field (unless poor weather conditions require it to seek shelter) and feeder vessel will transport the structure to the vessel.

The vessel operability characteristics also vary between HLVs and jack-ups. The Jack-up will likely be less sensitive to wave climate conditions due the vessel's ability to jack-up out of the splash-zone but will usually have a smaller crane in comparison to HLVs.

The vessel operator will plan, co-ordinate and execute the initial mobilization of the vessel. All grillages and sea fastening solutions will be presented to the Marine Warrantee Surveyors and Classification Society for approval before being fabricated and fitted. During the mobilization of the vessel, the offshore equipment intended for use is loaded.

The governing factors when you are choosing an installation vessel lies around the following:

- > Availability of vessel
- > Cost/Day rate of vessel
- > Mobilization/Demobilization costs and timeline
- > Installation rate/timeline
- > Operational limits of vessel (e.g. weather windows, Lift capacity, hook heights etc.)
- > Installation strategy, restrictions, requirements

For the U.S. Market, the Jones Act presents an added complication to offshore installation works for offshore windfarm developments. There are currently no Jones Act compliant vessels in the U.S. which are suitable for offshore structure installation works, and overseas vessels will need to be utilized. They will need to operate with a feeder vessel transfer operation which will need to be in accordance with the Jones Act.

## Cable Laying Vessel (“CLV”)

Early offshore wind farms tended to be sheltered ‘near shore’ environment and shallow water, and consequently simple anchored barges were utilized with carousels and cable lay equipment installed as required. As the wind farms have moved further offshore and became more exposed, more sophisticated cable lay vessels are required. Required cable lengths can now be around 100km, and larger purpose-built cable lay vessels with integrated carousels are required to carry these much longer cable lengths safely.

The new generation CLVs are multi-purpose: they are able to lay, trench and survey the cable employing an integrated system; with a typical dead weight of 9000Te, vessel length of 120m and 28m beam, these vessels are able to lay heavy and long cables. Equipped with a DP2 positioning system, they can position these cables accurately on the seabed. However, operations with these larger vessels may be restricted by shallow water. Factors to be considered, when selecting a CLV will include elements such as cargo capacities, maneuverability properties, bollard pull for cable plough, weather window and speed of installation etc. Since CLVs have a high day rate, the number of trips and transit times to the vendor port can be minimized by new material being transported to nearby load-out ports by cheaper transportation barges.



*New Generation of Cable Laying Vessel—Courtesy Boskalis*

## Offshore Support Vessels

Offshore Support Vessels (OSV) can offer a different range of services and some may have firefighting and medical support facilities, but usually they are less specialized and project usage may not demand a level of Dynamic Positioning (DP) redundancy. Primarily these vessels are used as:

- > Supply Vessels (e.g. Transportation Barges/ Crew Change);
- > Construction Support (Anchor Handling Tug, Trenching Vessel, Rock Dumping Vessel);
- > Survey Vessel.

Typical characteristics are described in the following Sections. Additionally, a Rock Dumping Vessel (RDV) is described.

## Transportation Vessels/Barges

Barges are employed widely in the offshore renewables industry for a range of activities, including transportation of components. These barges range in size and facilities from a truly ‘dumb’ barge to further sophisticated barges that can be ballasted and moored and are able to carry a range of deadweight cargo or equipment. Transportation vessels are usually self-propelled and have a higher transit speed when compared to barges. However, they also have higher day rates and generally offset the requirement for other vessels associated with a towed barge which require a tug vessel.



*Transportation Vessels/Barges*

## Anchor Handling Tugs

The main purpose of tugs is the towing or escorting of other ships such as transportation barges. Other tasks are trenching, salvage, anchor handling or firefighting. To master these tasks tug vessels have to be capable of generating large towing or pushing forces and require a high maneuverability.

## Rock Dump Vessel

In areas where trenching is difficult due to ground conditions the cables are laid on the surface of the seabed and then covered over with rocks. In this case rock dumping provides a cost efficient alternative and reduces the cable damage risks. Rock Dump Vessels (RDV) are increasingly used within the offshore renewables industry for a range of activities, including cable protection, crossings protection and scour remediation.

RDVs typically use Dynamic Positioning systems (usually DP2), large cranes and a flexible fall pipe system or side stone dumping system. With these features they are able to dump rocks on the seabed accurately. They can also transport and dump rocks of variable sizes. Side-discharging by means of crane is usually done in shallow waters, while fall pipes are more commonly used in deep-water rock-dumping operations.

## Survey Vessels

Before installing the cables, investigations should establish where the cables can be laid down to minimize the environmental impact and maximize the cable protection. To get detailed information about chart depth, topography, slope angles and seabed type it is very important to conduct a cable route survey. High technology boats with seabed mapping systems are used to collect this information accurately. Typically seabed mapping systems consist of a multi-beam echo sounder that emits a fan of sound-beam to the seafloor to scan a wide swath of the seabed in great detail. The image to the right shows the principle of the cable route survey.



Anchor Handling Tug



Rock Dump Vessel—Side Stone Dumping Systems and Flexible Fall Pipe System (Source: IADC and Seahorse)

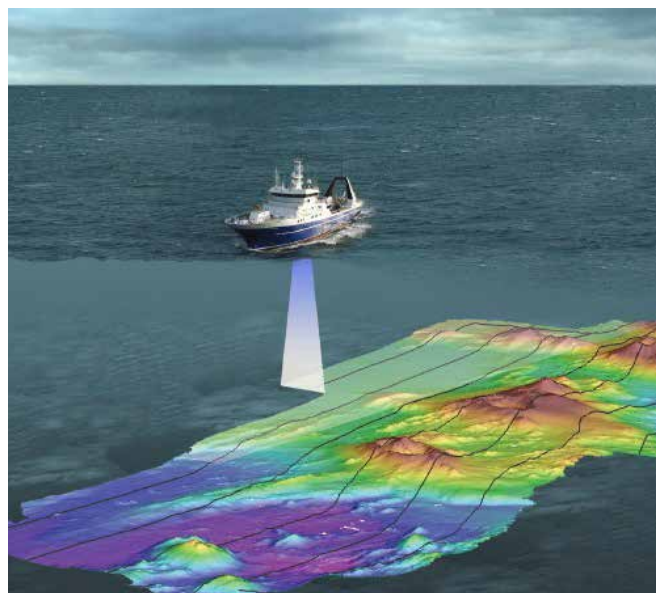

Cable Route Survey (Source: NIWA)

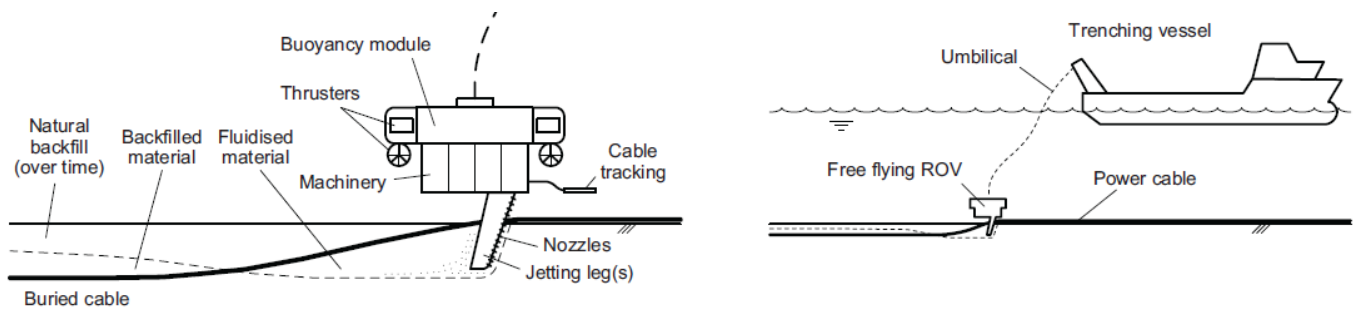

Figure 1 ROV Jet Trencher — Left: Principal Components, w<sup>o</sup> Right: Jet Trenching Operation (Source: DNV-RP-J301)

## Trenching Machinery

Special equipment is required to lay cables into different soil conditions. Four types of cable burial machinery can be identified namely with:

- > Cable burial ploughs;
- > Tracked cable burial machines;
- > Free Swimming ROVs with Cable Burial Capability;
- > Burial Sleds.

The three main trenching methods utilized by such machinery are Jetting, Ploughing and Cutting which are considered below.

## Trench Jetting

Jetting machines operate by pumping high-pressure water to fluidize or displace the soil. For electrical cables that are more flexible than pipelines and heavier than the surrounding soil, it is sufficient to form a slot of fluidized soil into which the cable is lowered, all within the footprint of the trenching machine itself.

Jetting machines are generally tracked self-propelled crawlers with a power cable required from the mother-ship. Being remotely-operated, they may sometimes be referred to as ROVs; they should not be confused with neutrally-buoyant ROVs that operate throughout the water-column, which can also be used for localized jetting operations that do not justify mobilization of tracked trenching machinery.

Jetting is particularly effective in sandy soils, less so in cohesive materials such as firm or stiff clays. Larger soil particles require more jetting power, so the method may be less successful in gravelly sands; indeed, in such conditions, there may be a tendency for the gravel particles to sink during the fluidization process, displacing the sand upwards. This aspect of the potential backfill material needs to be understood on a case-by-case basis.

The figure 1 above shows a typical ROV jet trencher and the principle of its operation.



Typical Tracked-ROV Jetting Machine (Source: Global Marine)

## Trench Ploughing

Ploughs are passive machines towed behind the mother-ship, where the towing distance is a function of water depth. This makes them less maneuverability than self-propelled machines, particularly in confined areas such as wind-farms, where cable routes have to be arranged to avoid conflict between the towing vessels and WTGs.

This method is generally effective in most soil types (granular and cohesive), although variable conditions such as stiff clays with embedded cobbles can be problematic. For electrical cables, the plough may be equipped with a cable depressor, so that the removed soil can be backfilled within the plough's footprint. Figure 2 shows a typical ploughing machine and the principle of its operation.

Specialist plough types include "rock-ripping" and "vibrating" variants. Both feature a narrowed plough share intended to penetrate the rock more efficiently. Deployment of rock-ripping ploughs tends to be more practical for the ripping of rocks and boulders cemented with soil (i.e. conglomerates and breccias) rather than directly upon solid rock. The vibrating plough is potentially more effective if it incorporates a strong impacting action on the rock; an example is shown in the adjacent photograph.

## Trench Cutting

Trench Cutting is performed using a similar self-propelled vehicle used for jetting, except that it is equipped with a cutter chain that creates a vertical slot into which the cable is lowered.

The technique is particularly suited to firm or stiff clays where jetting would be ineffective, and where the soil can maintain a vertical-sided profile. However, the rotating cutters present the greatest risk to the cable of the three trenching methods.

Figure 3 shows a typical chain cutter and the principle of its operation. Alternatively, a cutting wheel may be adopted. Both types of equipment are illustrated in the adjacent photograph.

Cutting into rock is feasible with such a system, but requires frequent replacement of the cutter's teeth, further hindering an already slow process.

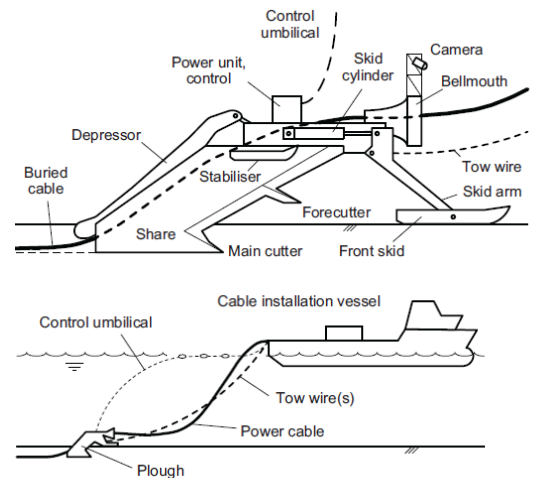

**Figure 2** Trench Cable Plough — Top: Principal Components, Bottom: Ploughing Operation (Source: DNV-RP-J301)



Subsea Vibrating Plough (Source: Louis Dreyfus Travocean)

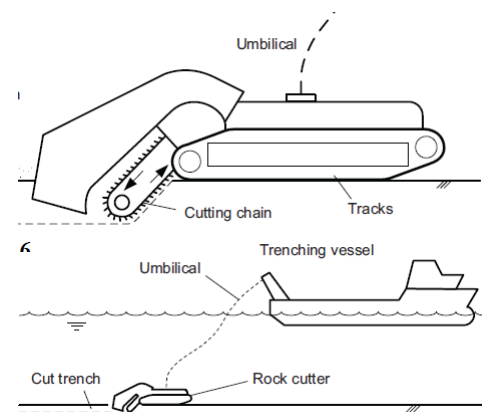

**Figure 3** Chain Cutter—Top: Principal Components, Bottom: Pre-Lay Rock cutting Operation (Source: DNV-RP-J301) DNV-RP-J301)



Subsea Trench Cutting Machinery (Source: Louis Dreyfus Travocean)



## Commissioning

All commissioning activities need to be coordinated to ensure safe and correct completion. It is essential that the Contractor develops a coordination program between the installation teams and the commissioning teams for all elements associated with the WTGs, array cables and OSS's.

As part of developing a detailed installation and commissioning program, the Contractor will need to develop an interface schedule which will identify a number of key hold points. These hold points will identify handover points between the different installation and commissioning teams for the OSS, export and array cables and WTGs. This will help to ensure safe handover of the assets and limit access to plant when undergoing commissioning.

The interface schedule will facilitate any overlapping activities, such as installing the turbine tower and the commissioning of the array cable on the same string. This can reduce the anticipated timescales associated with the commissioning of an array. However, coordination of these activities is key to minimize risk and manage safe working of the operations.

Health and Safety particularly in the offshore environment is paramount, therefore adequate provision must be made to ensure that personnel do not have access to any plant or equipment which is made "live" unless they are authorized to do so as part of the commissioning process. For example, the developing of control or permitting documentation associated with "hot" commissioning activities takes time to complete. For hot commissioning, the system must be commissioned as a whole. Each WTG can be hot commissioned separately, as long as it is associated array cable has been energized and hot commissioned. Once the WTG is hot commissioned, then it will enter the availability and reliability phase. In line with manufacturer's recommendations, then WTG must remain available and operate for a minimum of 360hrs, before it passes its availability and reliability test. Once this test is complete, then the WTG is available for generating.

Another key factor in the commissioning phase is the hook up to the OSS. Final commissioning of the OSS can be dependent on the ultimate delivery date of export cable. Once the OSS foundation has been installed, there will be an interface with cable pulling operations that need to be coordinated with either the Cable Laying Vessel or Heavy Lift Vessel, so that overall delivery schedule is not compromised.

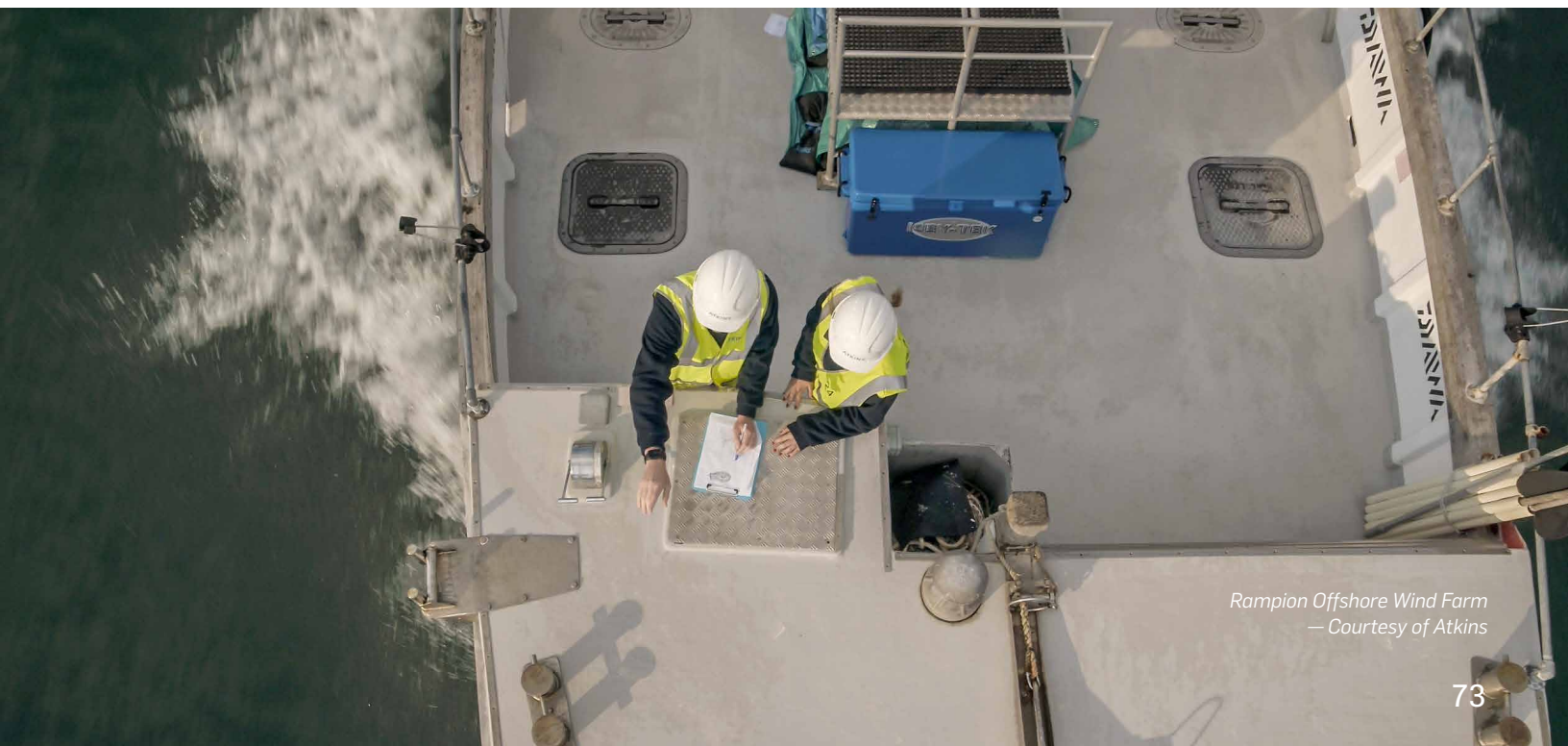

*Rampion Offshore Wind Farm  
— Courtesy of Atkins*



Thanet Offshore Wind Farm — Courtesy Vattenfall

# Asset Management and Decommissioning

AUTHORS: **Úna Brosnan and Andrew Thompson**, Atkins

## Operation and Maintenance

The operation and maintenance (“O&M”) costs of offshore wind farms contribute significantly to the energy generation costs. During this phase the owners seek to safely deliver financial returns for the project by aiming to surpass target power generation volumes/revenues while minimizing costs and risks.

An optimized O&M strategy will support both income generation and cost management and will influence the level of risk undertaken during the O&M phase. The O&M is driven by three key factors: availability, production and revenue. Therefore the strategy has to consider effective

management of the wind turbines and the balance of plant for the wind farm.

The chosen O&M approach will highly influence the level of revenue generated and availability of targets. The approach has to include maintenance planning and prioritization, a balance of proactive vs. reactive maintenance, repair contingency planning, windfarm accessibility, availability and the optimization of spare parts. Other important considerations include the effective management of the warranty and insurance claims during the initial defect notification period for the wind farm.

Below is a high-level summary of the O&M life cycle phases:

### O&M LIFE CYCLE PHASES

Phases	Definition
Pre-Operations	<ul style="list-style-type: none"> <li>&gt; Development of O&amp;M strategy, implementation plan, contracting, team mobilization and systems implementation, HSSE systems implementation, port development, O&amp;M base construction, handover from construction teams, contractual handover of the power plant equipment (Balance of Plant and Wind Turbines) to the project company.</li> </ul>
Warranty Operations	<ul style="list-style-type: none"> <li>&gt; Contract management, warranty and insurance claims, performance monitoring and management of availability guarantee, option to work alongside OEMs on technical investigations (WTG and BoP), interface management and stakeholder management, budgeting and financial control, development/ review of maintenance plans (WTG and BoP), option to deliver maintenance through the provision of owner’s technicians, spares/inventory audit (WTG) and management (BoP).</li> </ul>
Post-Warranty Operations	<ul style="list-style-type: none"> <li>&gt; Contract management, warranty and insurance claims, performance monitoring and management of availability guarantee, option to work alongside OEMs on technical investigations (WTG and BoP), interface management and stakeholder management, budgeting and financial control, development/ review of maintenance plans (WTG and BoP), option to deliver maintenance through the provision of owner’s technicians, spares/inventory audit (WTG) and management (BoP, options WTG), mid-life integrity review, planning of any required major corrective actions.</li> </ul>
Extended Life Operations/ End of Life	<ul style="list-style-type: none"> <li>&gt; Development of the business case, stakeholder engagement on life extension plan, asset integrity review (BoP and WTG), asset integrity improvement planning (including corrective actions).</li> <li>&gt; If life extension is not commercially favorable or viable, a move to the development of a detailed decommissioning plan for the site or to re-power by replacing the existing plant and equipment.</li> </ul>

An offshore windfarm, similar to any other form of power plant, requires 24-hour supervision, delivery of a preventative and reactive maintenance strategy, and requires the management of commercial contracts to deliver operations & maintenance services, in order to realize the viability of the asset through its ability to discharge power to the grid to generate its revenue.

The windfarm owner has ultimate responsibility for overall asset management, management of warranties and availability guarantees, power forecasting and local stakeholder management, regardless of the O&M strategy selected. Some elements of the operator's role may be subcontracted to external service providers, whilst other requirements can be delivered directly by the owner who may choose to be supported by experienced technical advisors.

Services provided by an external service provider can be undertaken by independent 3<sup>rd</sup> party companies, or companies involved in the supply of the original equipment i.e. Original Equipment Manufacturer ("OEM") during the construction phase as part of initial warranty guarantees.

In addition, the owner must also take care of the overall management of their business which can be established as a Special Purpose Vehicle (SPV), and which would include corporate governance, investor reporting, financial management and procurement.

## Life Extension

Offshore windfarms to date have been designed to operate for 20 to 25-year periods. This requirement is then aligned with technical design considerations, commercial factors (operational costs, grid connection charges, power prices and support regimes) along with legal arrangements including leases, licenses and consents.

The ability to generate electricity over a longer asset lifetime using all or elements of the existing asset presents an opportunity to deliver a lower Levelized Cost of Energy ("LCOE"). Investment models are generally set up to pay off capital investment over the first 15–20 years

of the operational life of the windfarm, therefore returns beyond this capital payback period increase considerably. In order to extend the operational life of an offshore windfarm asset, it is necessary to ensure leases, consents, and wayleaves can remain in place beyond the initial design life. It is then clearly important that the commercial landscape encourages continued investment, and that plant integrity can be assured over the extended operational life.

To support the commercial business case for life extension, robust assessment of the integrity of the offshore windfarm assets is required. If integrity can be assured, then offshore wind offers a potentially attractive source of relatively low-cost power generation once the initial capital investment has been depreciated. In the offshore hydrocarbon sector, extending the operational life of offshore structures is extensive, and although the offshore wind industry is still quiet young we have a number of the early offshore wind farm coming to their end of life, where similar life extension, practices may be implemented.

The operational life of offshore windfarms can be extended through the use of monitoring data over the life time of the structure combined with asset integrity analysis to understand the integrity of the structure and its true current age. Experience has been steadily building over the last ten years as an increasing numbers of offshore wind turbines are deployed. Engineers' understanding of aging processes is growing. Solutions for life extension already exist for foundations and some of the main components within the wind turbine. Greater knowledge of the aging processes is required to support long term management of plant integrity, and the development of associated damage models will enable more efficient investment through the life of the windfarm. The view within the industry is that particular focus is currently needed on cable systems, turbine towers and nacelle structures and blades.

An alternative and/or combined approach to using asset integrity analysis coupled to upgrading or replacing key sub-components is to re-plant new turbines onto existing foundations, along with the re-use of the high voltage

network and grid connection. This option would likely be a lower cost than providing entirely new foundations and cables, as long as the integrity of the underlying infrastructure can be assured.

Maintenance strategies do need to consider the potential diminishing economic value of repairing high impact failures, coupled with consideration of future extended life opportunities. Decision support models are starting to be developed to address this need. Greater focus is needed on the underlying damage models that support this decision process, which in turn, requires a clear understanding of the original design basis and the impact of real-life operational environment on original design assumptions.

In order to exploit the potential benefits of life extension, it is advised that condition monitoring for foundations and cables should be considered in the detailed design stage and the collection of data be included in the O&M strategy. Aside from supporting life extension, data is a valuable tool in assessing on-going O&M performance, optimizing logistics and maintenance strategies and providing information to support the long-term management of plant integrity.

## Decommissioning

Offshore windfarm assets which have been in service beyond their design life (or their extended life) will need to be decommissioned safely and with minimal costs. Much of the decommissioning process is like the installation process, but in reverse. Decommissioning activities required for offshore elements are primarily based on experience gained from the oil and gas industry. To date, there are only a very limited number of offshore windfarms that have undergone decommissioning activities, however, some of the early stage windfarms in Europe are now nearing the end of their design life.

A major part of the decommissioning activity is associated with the environmentally neutral removal of offshore substructures and foundations and their transportation to shore. The dismantling of the major

WTG components would be carried out offshore, as would the removal of the OSS topsides. However, the dismantling of the sub-components associated with the WTG and OSS is assumed to take place onshore prior to re-use, recycling or disposal.

Typically, the activities for removing the offshore structures will involve the following activities:

- > De-energizing electrical equipment; draining or sealing off liquids; removing or securing loose equipment; strengthening lifting points;
- > Disconnection of the submarine export cables at the OSP, and then lower and rebury in the sea bed or cut and remove the cable ends near the seabed and bury the remaining ends;
- > Removal of the topside including substation, platform and associated superstructure from the foundation;
- > Removal of the foundation to below the level of the seabed (e.g. for a jacket foundation, cutting through the piles) and reinstatement of the seabed;
- > Removal of any scour protection from the seabed (subject to the Environmental impact assessment);
- > Transport of the topside and foundation to a suitable land-based facility;
- > Dismantling the topside structure and foundation and recovery of relevant components or recycling as appropriate.

Decommissioning of offshore electrical systems should be relatively straight forward, in that, the topside on which the electrical systems are located will be dismantled in a controlled environment such as a shipyard. This will generally encompass the following:

- > Dismantling of the electrical equipment;
- > Removal from the shipyard for disposal or recycling, as applicable.

Electrical equipment is manufactured from materials that can, by and large, be readily recycled, such as steel, aluminum and copper etc. This is usually undertaken by specialist contractors, since in some circumstances dangerous materials can remain present. Care must be taken as the equipment contains substances which will require special handling and disposal. These items include, but are not limited to:

- > SF6 Gas (HV Switchgear)
- > Battery acids from the UPS (Uninterruptible Power Supplies)
- > Diesel and oil from the Emergency Generator
- > Transformer Oil and Oil impregnated papers

All the substances will need to be disposed of in line with the legislation in place at time of decommissioning.

In addition to technical tasks, there are general activities associated with transport and logistics, to include hire: of specialist marine vessels needed for the 'heavy lift' to remove the topside and foundation, and possibly, suitable barges to transport them to shore depending on the deck space of the heavy lift crane vessel.

In the main, it is a requirement of the offshore windfarm lease and associated in-country environmental licensing, that during and post-decommissioning, the seabed is monitored to confirm the status of marine life, and that any disruption caused by the decommissioning works has not had long term detriment to the environment. The timing and scope of the surveying and monitoring is dependent on the footprint of the platform and associated scour protection. In the UK, the expectation is for a survey immediately following the removal of the marine assets, and then a survey at years three and eight post-decommissioning. Monitoring will normally be carried out via Remotely Operated Vehicle (ROV), and sampling of marine fauna and flora. Regular reports on the restorative process and environmental recovery should be submitted to relevant authorities.



*Illustration of Hywind Tampen Floating Wind Farm  
— Courtesy of Equinor*

# Appendix A: Contributors

## K&L GATES

---

### Toks A. Arowojolu

**Associate**

Washington, D.C.  
+1.202.778.9016  
Toks.arowojolu@klgates.com

### Elizabeth Crouse

**Partner**

Seattle  
+1.206.370.6793  
elizabeth.crouse@klgates.com

### Buck B. Endemann

**Partner**

San Francisco  
+1.415.882.8016  
buck.endemann@klgates.com

### Lindsey Greer

**Associate**

Charleston  
+1.843.579.5641  
lindsey.greer@klgates.com

### David P. Hattery

**Practice Group Coordinator —  
Power Group**

Seattle  
+1.206.370.7823  
david.hattery@klgates.com

### William H. Holmes

**Partner**

Portland  
+1.503.226.5767  
bill.holmes@klgates.com

### William M. Keyser

**Practice Group Coordinator—  
Power Group**

Washington, D.C.  
+1.202.661.3863  
william.keyser@klgates.com

### William N. Myhre

**Partner**

Washington, D.C.  
+1.202.661.6222  
william.myhre@klgates.com

### Michael L. O'Neill

**Associate**

Boston  
+1.617.951.9190  
mike.oneill@klgates.com

### Charles Purcell

**Partner**

Seattle  
+1.206.370.8369  
charles.purcell@klgates.com

### Ankur K. Tohan

**Partner**

Seattle  
+1.206.370.7658  
ankur.tohan@klgates.com

### David L. Wochner

**Practice Area Leader—  
Policy/Regulatory**

Washington, D.C.  
+1.202.778.9014  
david.wochner@klgates.com

## Atkins

---

### Úna Brosnan

**Business & Strategy  
Development Manager**

Glasgow, UK  
+44 7714 429919  
una.brosnan@atkinsglobal.com

### Michael Golden

**Senior Scientist**

Colorado  
+1.720.475.7096  
michael.golden@atkinsglobal.com

### Andrew Thompson

**Head of Offshore Wind**

Bristol, UK  
+44 1454 662662  
andrew.thompson@atkinsglobal.com

### Norma Villafaña

**Senior Graphic Designer**

Orlando  
+1.407.806.4290  
norma.villafana@atkinsglobal.com

# Appendix B: Company Background

## K&L GATES

With a power practice group of 100 lawyers in the U.S., and more than 150 lawyers in the practice group globally, we serve clients in virtually all renewable energy and utility sectors across the globe. Our clients operate in onshore and offshore wind, solar, biomass, hydropower, geothermal, and complementary sectors, including energy storage, smart grid, and transmission. Our power group operates within our seamless, full-service, global platform of more than 1,800 lawyers in offices across five continents.

### WE KNOW THE ENERGY BUSINESS

The lawyers of K&L Gates have represented clients in wind projects across the U.S. and around the world. Our firm combines long experience in thermal and renewable energy project development with a thorough understanding of the issues involved in permitting, financing, constructing, operating, and maintaining wind power and other infrastructure projects in a marine environment. Our clients include investor-owned and publicly-owned utilities, independent power producers, project developers, EPC contractors, turbine manufacturers, investors, and emerging businesses in the energy sector.

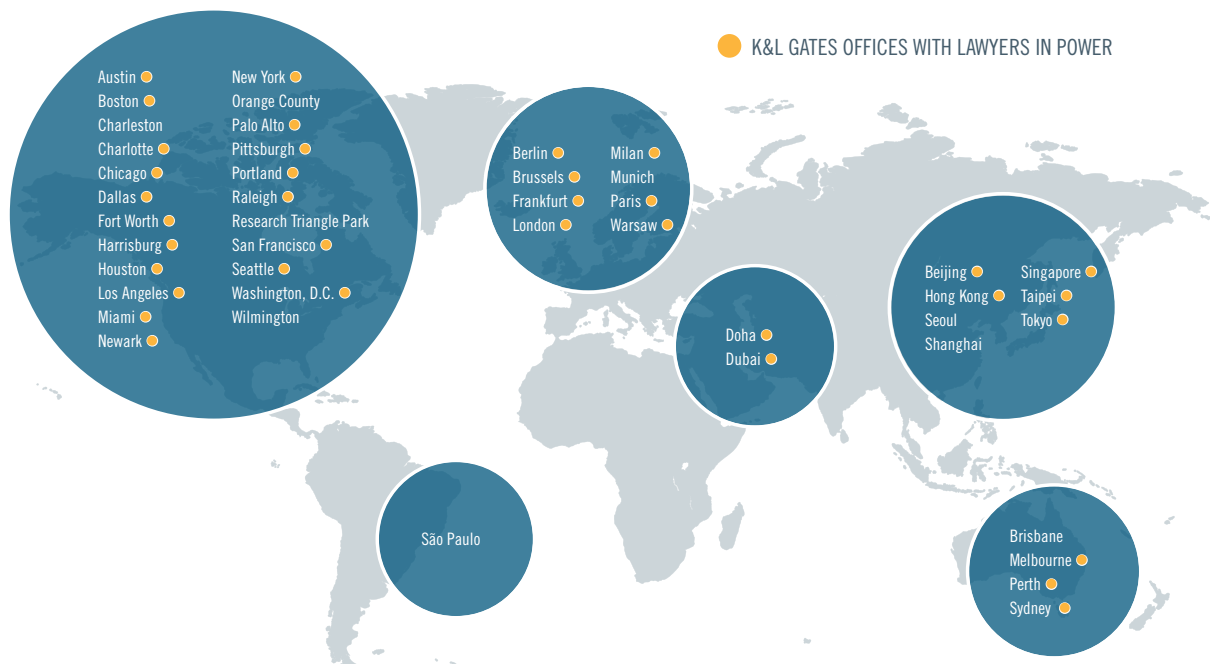





**ATKINS**  
Member of the SNC-Lavalin Group

# Offshore Wind

We are a global engineering, procurement and construction provider with years of experience in providing tailored solutions to the offshore wind industry. This expertise includes providing all aspects of engineering and construction throughout the life-cycle of an offshore wind project. Our portfolio also includes projects throughout the world making SNC-Lavalin a dominant provider in the global wind industry.

Our offshore capabilities include market leading expertise in the full design of both fixed and floating Wind Turbine Foundation design as well as the full design of Offshore Substations. Our team's experience in Offshore wind is unparalleled and includes monopiles.

- > Project Development support including feasibility studies, CAPEX/OPEX optimization
- > Environmental studies and Permitting (Local, State, Federal)
- > Geotechnical and geophysical engineering expertise

## OFFSHORE WIND EXPERIENCE



### OVER 50 YEARS' EXPERIENCE

With over 40 years in the oil and gas industry and over 10 years in offshore wind



### 19 OFFSHORE SUBSTATIONS FULLY DESIGNED

So far, 5 of which have been successfully fabricated and installed



### 250+ WIND TURBINE GENERATOR FOUNDATIONS

Designed or in design covering monopile and jacket studies



### 400+ OPERATIONAL STRUCTURES

Where we provide ongoing integrity assurance/management, inspection, and remediation support, covering WTG and OSP structures



### 4 FLOATING CONCEPTS THAT WE'RE INVOLVED IN

Hywind, Windfloat, Hexicon and Kincardine, with water depths of 45m to 143m



### 300+ GEOTECHNICAL AND STRUCTURAL OFFSHORE ENGINEERS

Many have developed some unique solutions for the offshore wind industry

[snclavalin.com](http://snclavalin.com) | [atkinglobal.com](http://atkinglobal.com)





# ATKINS

Member of the SNC-Lavalin Group

SNC-Lavalin's Atkins business is one of the world's most respected design, engineering and project management consultancies with a deep history in offshore engineering. We operate globally and are one of very few firms to provide clients with comprehensive end-to-end project solutions – including financing and asset management, consulting and advisory, digital and artificial intelligence, design and engineering, procurement, project and construction management, operations and maintenance and sustaining capital. For more information about SNC-Lavalin or its locations, visit [snclavalin.com](https://snclavalin.com)

## K&L GATES

K&L Gates is a fully integrated law firm with lawyers located across five continents. The firm represents leading multinational corporations, growth and middle-market companies, capital markets participants, and entrepreneurs in every major industry group, as well as public sector entities, educational institutions, philanthropic organizations and individuals. For more information about K&L Gates or its locations, practices and registrations, visit [klgates.com](https://klgates.com)